

I - EXECUTIVE SUMMARY



This synthesis, coordinated and edited by Nick S. Fisher, was initiated during the Ancona meeting and prepared by all the workshop participants.

1 - INTRODUCTION

The workshop was held from 27 to 30 October 2002 in Ancona, a busy port in the Marches region on the Italian Adriatic coast. The workshop was hosted by the Istituto di Ricerche sulla Pesca Marittima (IRPEM), through the kind assistance of its Director, Dr. Antonio Artegiani, who serves as National Representative of Italy on the CIESM Board. Eighteen scientists (see list at the end of this volume) participated at the invitation of CIESM.

In their opening remarks, Prs Frederic Briand and Nicholas Fisher, Director General of CIESM and Chair of its Marine Biogeochemistry Committee respectively, provided the overall philosophy behind such research workshops. They encouraged the participants to avoid a simple review of their own work or of the field in general, recommending instead that discussions aim to produce a constructive synthesis and critique of the major developments in the area of metal/radionuclide bioaccumulation in marine organisms together with some recommendations for future work in this broad and growing field.

Bioaccumulation (defined here as association of a metal with an organism) is a necessary first step before organisms can manifest a response to metals or influence metal geochemical cycling. Many studies have been conducted in recent years to evaluate the rates and mechanisms of metal bioaccumulation in marine organisms. These studies have been motivated in part by a number of practical issues, such as public health concerns arising from the consumption of contaminated seafood, a need to establish improved water or sediment quality criteria in coastal regions, and risk assessment exercises (for both marine communities and human populations) which require information on bioconcentration factors for contaminants in diverse marine organisms. Risk assessments have been particularly applied to long-lived components of radioactive wastes emanating from the nuclear fuel cycle, most of which are metals. However, there is also considerable interest in understanding metal accumulation in marine organisms as they can greatly influence the cycling, fluxes, and residence times of metals/radionuclides in marine systems. Moreover, the recognition that low concentrations of some essential metals in a bioavailable form can be limiting to some marine organisms, most notably iron to phytoplankton in high nutrient, low chlorophyll (HNLC) areas of the oceans, has spurred many recent studies on relating metal speciation in water to bioavailability and metal accumulation to metabolic responses.

The short papers that follow in this volume consider such matters as (1) relating metal speciation (chemical and physical) to metal bioavailability to marine organisms; (2) environmental (or external) and physiological (internal) controls of metal fluxes through marine organisms; (3) evaluating the significance of metal uptake by organisms for understanding metal fluxes and residence times in oceanic systems; (4) relating biological responses (e.g., growth, toxicity) to pathways of metal uptake; (5) biochemical distributions of metals in marine organisms and their implications for metal toxicity and trophic transfer; and (6) modeling metal bioaccumulation in marine organisms and an evaluation of its appropriateness to understanding metal concentrations in marine organisms.

A number of publications have presented organizing principles by which the fate and effects of broad classes of metals can be understood and predicted in marine systems. These include geochemical considerations (Whitfield and Turner, 1987), general biological interactions (Nieboer

and Richardson, 1980), including bioaccumulation in marine organisms (Williams, 1981; Fisher, 1986) and toxicological effects (Shaw, 1954; Kaiser, 1980; Nieboer and Sanford, 1985). The advantages and limitations of these broad groupings of metals based on properties of the metal ions themselves were discussed by Rainbow (1997a), who focused on metal interactions with marine invertebrates. Despite some limitations, such generalizations were considered useful and sometimes provided penetrating insights into the nature of metal binding to, or effects on, marine organisms. They helped form the framework for the discussions of this Workshop which considered the processes governing metal bioaccumulation in marine organisms including analytical, monitoring, and modeling tools for studying these processes, and the geochemical and biological consequences of this accumulation.

2 - METAL BIOAVAILABILITY

2.1. Speciation effects in solution

Laboratory and field observations clearly indicate that the total concentration of a metal, in solution (“dissolved” metal) or associated with particles (“particulate” metal), is rarely a good predictor of metal bioaccumulation or toxicity in aquatic organisms. On the other hand, environmental geochemists have demonstrated that metals exist in a variety of physical and chemical forms in the water column and in the bottom sediments. Faced with these general observations, environmental scientists and managers have rather uncritically accepted the notion that some fraction of the total metal concentration is “bioavailable”. There is no doubt that this statement is qualitatively correct, but it has proven difficult to develop a universally applicable quantitative definition of “bioavailability”. Two major factors contribute to this dilemma: (i) the diversity of routes by which metals may in fact be bioaccumulated by aquatic organisms, and (ii) the dynamic nature of metal speciation (and the analytical limitations to measuring this speciation).

With respect to the first factor, one can make a useful first distinction between those organisms that are exposed only to dissolved metals, e.g. bacterioplankton, phytoplankton cells, or macrophytes, and those that are exposed both to dissolved metals and to metals that are incorporated into their ingested food, e.g. protozoa, zooplankton and higher herbivores / carnivores. However, even within these classes there will exist a wide variety of routes of metal uptake. For example, even for a simple unicellular alga (Fig. 1), metals may enter the cell by facilitated cation transport, by facilitated anion transport and by passive diffusion of lipophilic metal forms; the relative importance of these uptake pathways will vary from one algal cell to another. Similarly, while similar transport systems will exist at gill and intestinal epithelia, the relative importance of the different uptake

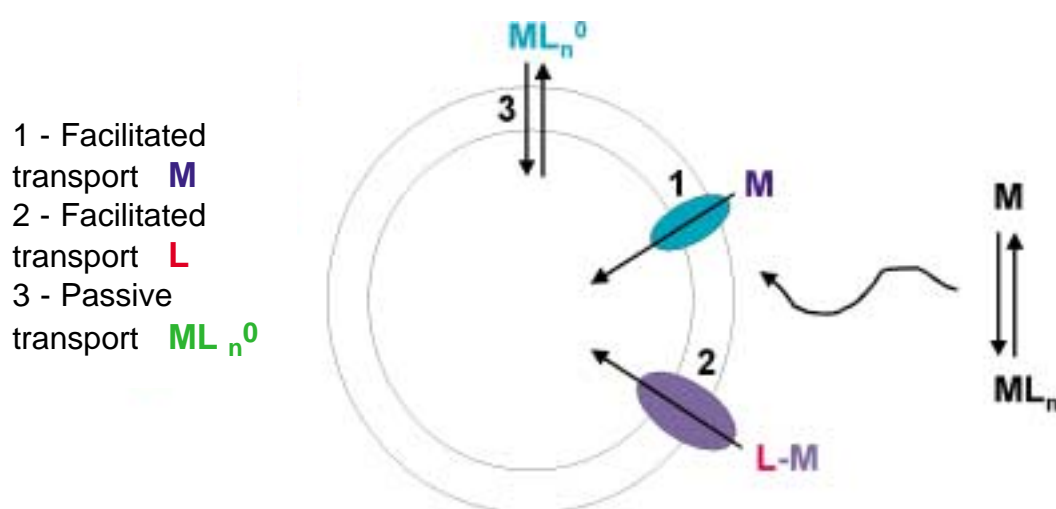

Fig. 1. General scheme showing how metals may enter living cells: (1) carrier-mediated cation transport and/or cation-channel transport; (2) carrier-mediated transport of metal-ligand anionic complexes; (3) passive transport of lipophilic metal forms.

routes will vary from one biological interface to another. In addition, in a given aquatic environment the indigenous organisms will tend to occupy different (micro)habitats; if the chemical conditions (e.g., $[O_2]$, pH, pCl, [dissolved organic matter]) in these microhabitats differ, then metal speciation and bioavailability will also vary from one microhabitat to another within the given (macro)environment. For both these reasons (different routes of exposure to metals and different physiologies; different microhabitats), it follows that even in a defined aquatic environment, metal “bioavailability” will not be a constant property of the system but will tend to vary from one organism to another.

The influence of the second factor, i.e. the dynamic nature of metal speciation, is perhaps a little more subtle. In most cases, the distribution of a metal among its various chemical forms (see Fig. 2) is very rapid. Under such circumstances, if one particular metal form is taken up from the exposure solution (e.g., the free metal ion), its concentration will decrease only transiently; the external equilibria will immediately adjust to replenish the metal form that has been taken up. Laboratory experiments suggest that this general scenario is often played out in just this manner. If this is the case, the free metal ion activity will be the best predictor of metal uptake from solution, but it cannot legitimately be described as the “bioavailable form” of the metal because, in fact, all of the forms in equilibrium with the free metal ion are contributing to the uptake flux by maintaining the external free ion concentration/activity.

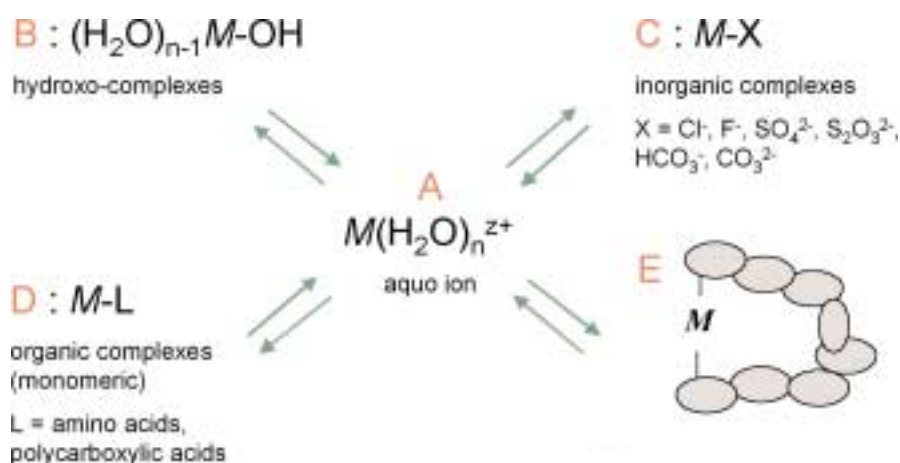

Fig. 2. Examples of metal “species” found in natural waters.

Trace metals are taken up by aquatic organisms from solution across the cell membrane of permeable surfaces by one or more transport routes (Blust; Campbell; Rainbow, this volume), including:

- carrier-mediated transport whereby a metal ion binds with a membrane protein;
- a membrane channel consisting of a protein with a hydrophilic core through which metal ions are transported, perhaps to be considered as a variant of the carrier protein route;
- passive diffusion of lipid-soluble (non-polar) metal forms which dissolve in the lipid bilayer, including alkyl-metal compounds and neutral, lipophilic, inorganically complexed metal species (e.g., $HgCl_2^0$);
- endocytosis when a region of the cell membrane invaginates to engulf a metalliferous particle for transfer into an intracellular vesicle.

Once trace metals cross the cell membrane, their binding with non-membrane permeable cytosolic proteins of higher affinity for the metal ensures that they continue to enter passively, even though the internal concentration of total metal in the cell is higher than the external dissolved metal concentration. Major ions like Na^+ and K^+ do not have such high affinities for complexing agents,

including proteins, and remain relatively uncomplexed in the intracellular environment; maintenance of the concentration gradients for these metal ions may require the use of energy, e.g., involvement of membrane-bound ATP-ases.

2.2. Metal bioavailability from food sources

As mentioned above, it is generally considered that the free metal ion is available for transport across the cell membrane via a carrier protein or through a membrane channel, and therefore the free metal ion will often be the best predictor of uptake of metal from the dissolved phase (Campbell, this volume). Whereas organisms positioned at the bottom of the food web such as unicellular algae take up metals exclusively (or predominantly) from the dissolved phase (with the exception of rooted plants), organisms positioned at higher trophic levels are exposed via other routes including suspended matter, sediment particles and different food sources. This creates a more complex situation so that the relationship between the free metal ion concentration and metal uptake may be lost.

Inside an organism, metals are distributed among different compartments, of which some are strong accumulators (e.g., liver and kidney) and others are much weaker accumulators (e.g., muscle tissue). Inside the cells of the tissues the metals are bound to different types of ligands and partitioned into exchangeable (or labile) and non-exchangeable (or inert) metal pools. Thus, inside an organism metals occur in various compartments and forms, the chemical speciation of which is very different from that in the external environment. Feeding involves the ingestion and digestion of food items (which may include suspended or deposited sediment particles). Depending on their physiology and position in the food web, organisms have developed different feeding and digestion strategies. This also means that the way in which the metals are processed during the digestion process may be very different, resulting in potentially large differences in metal assimilation efficiencies. Several studies have indeed shown that assimilation efficiencies of metals from food strongly depend on food preference, feeding strategy, and digestive physiology. Hence, a direct relationship between the free metal ion concentration in the exposure solution and metal uptake by an animal will only be found when (i) uptake via water is the predominant exposure route, or (ii) the concentrations of the metals present in the food items are proportional to the ambient free metal ion activity, and assimilation efficiency is invariant across different milieus.

In addition, aquatic organisms have developed different strategies to deal with metals. Some metals are essential nutrients for which the body or tissue concentrations are more or less under homeostatic control (e.g., copper or zinc), whereas others are not essential and do not appear to be regulated very strongly (e.g., cadmium or mercury). Regulation can occur in two different ways, either by matching metal excretion to metal uptake so that the internal body concentration of the metal remains constant, or by storing part of the metal in a physiologically inactive pool. Aquatic organisms employ both strategies and in many cases effective regulation and/or detoxification is achieved by combining the two methods. Together with the relative importance of different exposure routes, these differences in internal processing explain why there can be important differences in body metal concentrations and internal metal speciation among organisms from the same environment.

2.3. Biogeochemical oceanographic considerations

To this point we have emphasized the influence of chemical speciation of trace metals on metal bioavailability. The physical speciation of metals can also strongly influence their fate and behavior in marine ecosystems. Thus, metals that show little binding to particulate matter in marine systems (i.e., conservative metals such as uranium or technetium) will be relatively unavailable for uptake by marine herbivores through trophic transfer since there will be little or no uptake of these metals from the dissolved phase into the phytoplankton food. Further, the cycling and fluxes of these metals will not be affected by particles, and hence their oceanic residence times approach that of the water itself.

Many metals do however associate to varying extents with particulate matter and these metals can be accumulated in animals both from ingested particulate matter (i.e., food) as well as from the dissolved phase. The fluxes of these metals are strongly influenced by particle flux, including biogenic particles such as sinking fecal pellets or phytodetritus, which are highly enriched in

metals (Fowler, 1982; Fowler and Knauer, 1986), and abiotic particulate matter. The most particle-reactive metals have oceanic residence times approaching those of the particles themselves. Their residence times in the ocean, and most particularly in surface waters, tend to be very short and have been shown to be closely related to the metal concentration factor in sinking biodebris (Cherry *et al.*, 1978). Many particle-reactive metals are Class A metals, which have a high affinity for oxygen ligands; examples include thorium, aluminium, plutonium, and many of the lanthanides (Whitfield and Turner, 1987). By size-fractionating metals in surface seawater, it can be shown that some metals presumed to be “dissolved” (i.e., they would pass through a 0.2 or 0.45 μm filter) are, in fact, bound to colloidal particles, operationally defined as suspended material that behaves like particles but is smaller than the common “cut-off” for particulate matter (either 0.2 or 0.45 μm). Many of these Class A, particle-reactive metals show appreciable and rapid binding to colloidal particulate matter, probably because of the very high surface to volume ratios of these very small particles and possibly because, as well, there are numerous oxygen-containing binding groups on the surfaces of these colloids to which the metals can bind. Subsequently, these colloidally-bound metals can associate with larger particles such as phytoplankton cells via particle-particle interactions (Honeyman, 1991). Such colloidally delivered metals cannot easily be transported into the cytoplasm of cells, either by carrier proteins or enzymatic action, and as well would have relatively little chance of diffusing across the cell membranes into the cytoplasm because these metals are not, for the most part, bound directly to the cell surface but rather to colloidal matter which in turn is bound to cell surfaces.

Thus, these metals are often found associated with the surfaces of microbial cells, generally showing little penetration into the cytoplasm of these cells. Consequently, when these cells are eaten by herbivores, these surface-bound metals display little assimilation into the tissues of the herbivores and get released from the animals packaged into fecal pellets. Cytoplasmically distributed metals tend to be assimilated into the tissues of herbivores; generally, a very tight relationship has been observed between assimilation efficiencies of ingested trace metals and the cytoplasmic distribution of these elements for herbivores (e.g., copepods, bivalve larvae) with relatively simple guts and short gut transit times (Fig. 3). Note that the slope of the regression shown in Figure 3 is

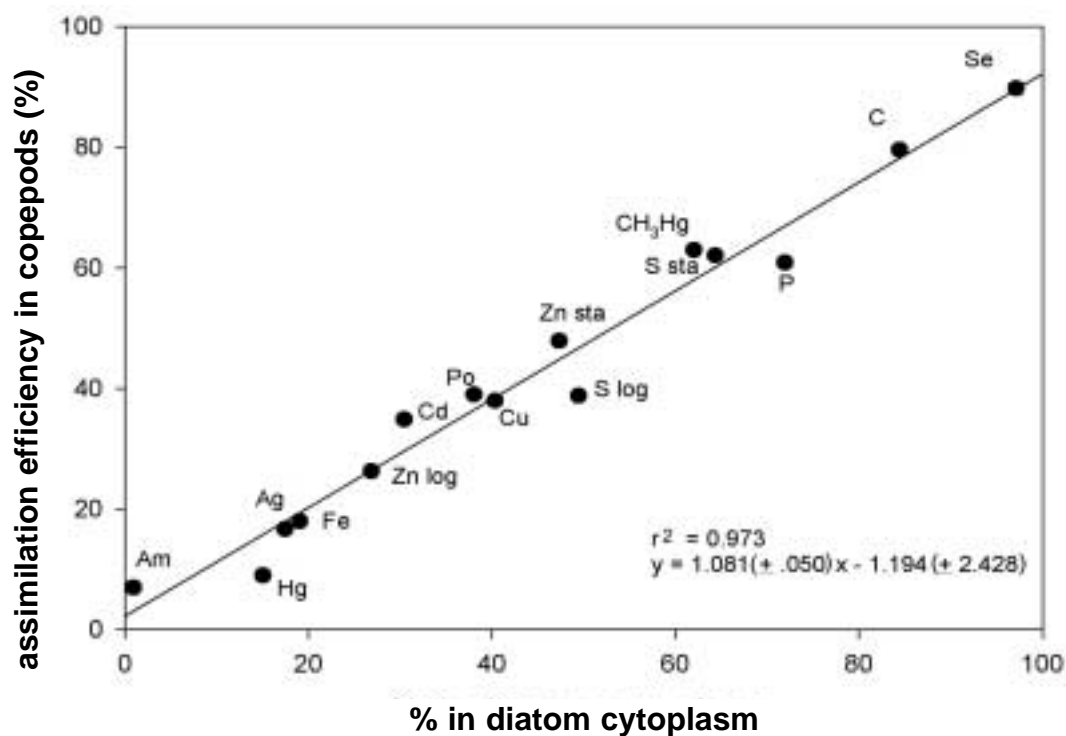

Fig. 3. Relationship between assimilation efficiency (%) of ingested elements in marine copepods and their cytoplasmic distribution in the diatom (*Thalassiosira* spp.) prey. For S and Zn, both stationary phase (sta) and log-phase (log) diatom cultures were examined. Data from Reinfelder and Fisher (1991), Hutchins *et al.* (1995), Mason *et al.* (1996), Sung and Reinfelder (2000), and Stewart and Fisher (unpubl.).

not significantly different from 1 and the intercept not different from 0. The relationship displayed in Fig. 3 between assimilation efficiency of ingested metals in zooplankton and the cytoplasmic distribution of metals in the phytoplankton food is remarkably robust and holds for both essential and non-essential elements. The data for this Figure, compiled for this report from various recent studies, clearly indicate that the assimilation of ingested metals by zooplankton can be predicted based on the distribution of metal in the food. This correlation between cellular distribution in the food and assimilation efficiency in the herbivore is still apparent but considerably less robust for animals with longer gut residence times and more complicated guts (e.g., adult mussels). Fecal pellets produced by pelagic zooplankton can often sink at rates of 50-150 m day⁻¹ (Turner, 2002); hence these metals get transferred rapidly into deeper waters or even sediments. Further, because these particle-reactive metals typically display little assimilation into animal tissues, they show little build-up in marine food chains. Since the resulting concentrations of these metals in marine animals are relatively low due to this low assimilation, these metals would not be expected to exert any toxic action on marine animals nor would they likely pose a public-health problem for human consumers of seafood.

It is noteworthy that even the most particle-reactive metals are predominantly in the dissolved (or colloidal) phase in most marine waters (Fig. 4). This observation simply reflects the fact that suspended particle loads in seawater tend to be low, rarely exceeding 10 mg L⁻¹ in surface waters, and often in the 0.1-2 mg L⁻¹ range. In turbid estuaries, however, particle loads can be quite high (this loading varies enormously among estuaries and with season), and in these systems a concomitantly greater proportion of the total metal will be associated with particulate matter.

In contrast to the Class A cations, many of the transition metals show intermediate or even high reactivity for particulate matter but negligibly small association with colloidal matter in seawater. These metals may bind to cell surfaces directly, and therefore can get transported to a greater extent into the cytoplasm of phytoplankton cells. When these cells are eaten by herbivores, these

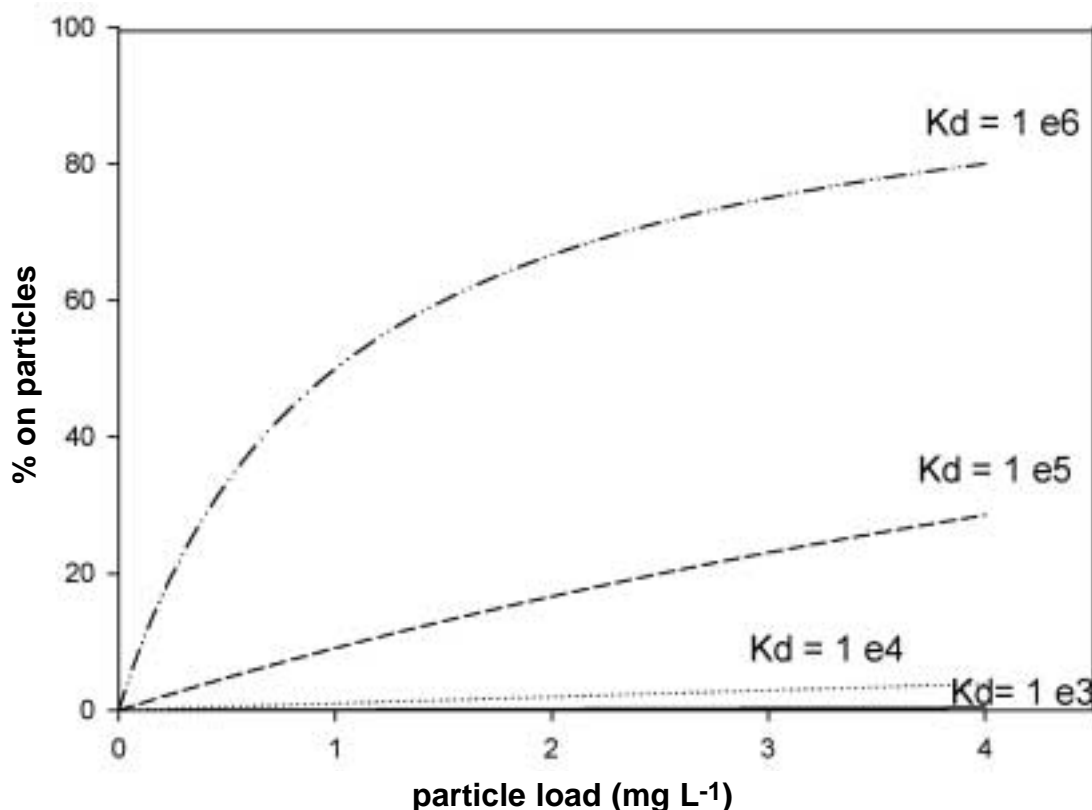

Fig. 4. Calculated partitioning of metals with K_d s (equal to dry wt. concentration factors) ranging from 10^3 to 10^6 on to particles over a suspended particulate load range of 0 to 4 mg L⁻¹. Note that for typical surface seawater particle loads (≈ 1 mg L⁻¹), even the most particle-reactive metals are predominantly in the dissolved phase. Most metals have K_d s $< 10^5$ (Fisher, 1986).

cytoplasmically associated metals get assimilated into the animal tissue, have a chance to build up to appreciable concentrations in the tissues of marine animals, and thus may pose a threat either to these animals (toxicity) or to human consumers. Because these metals become more closely associated with the carbon cycle, they get recycled biologically by organisms, and consequently display longer oceanic residence times (Fig. 5). Thus, metals display a positive relationship between assimilation efficiencies in zooplankton and oceanic residence times and an inverse relationship between concentration factors in phytoplankton (or any particles) and oceanic residence times.

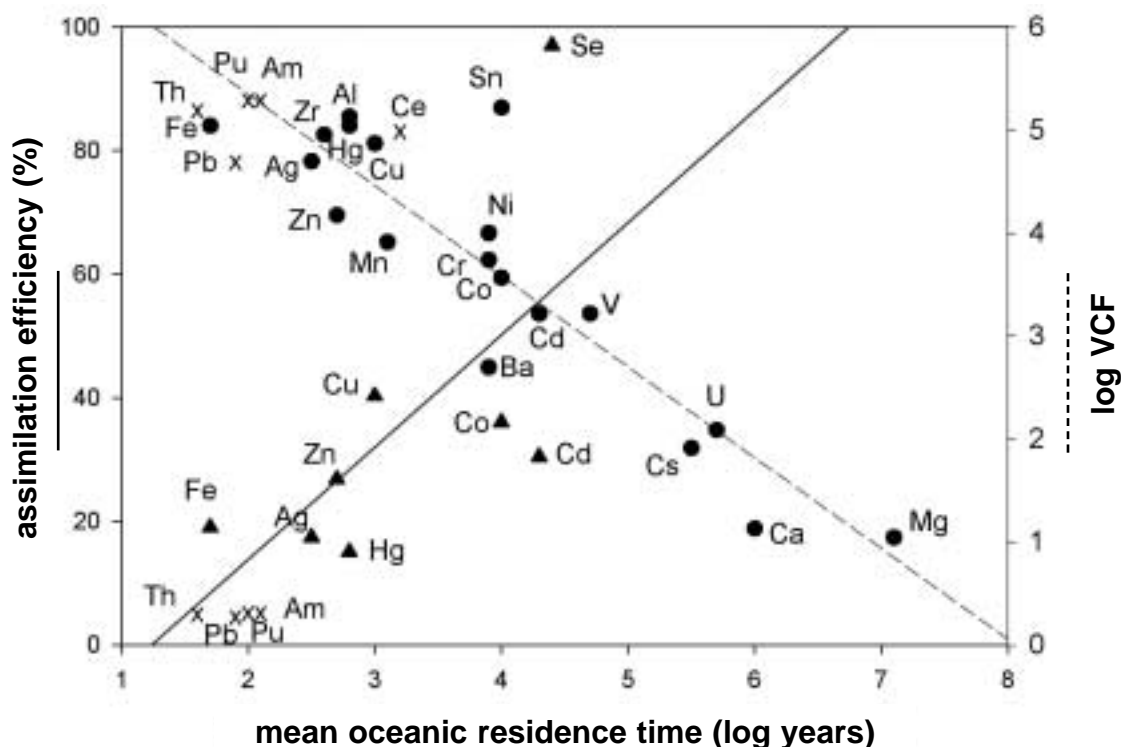

Fig. 5. Relationship between assimilation efficiency (%) of ingested metals in marine copepods (left y-axis) and mean oceanic residence times of the metals (log years) (triangles connected by solid line, $y = 18.15 (\pm 8.48) x - 22.4 (\pm 27.9)$; $r^2 = 0.621$); relationship between log volume concentration factor (VCF, right y-axis) of metals in phytoplankton and mean oceanic residence time of the metals (circles connected by dashed line, $y = -1.014 (\pm 0.114) x + 7.276 (\pm 0.474)$; $r^2 = 0.835$). Note: elements denoted by "x" associate appreciably with colloidal matter in seawater. Adapted from Fisher (1986) and Fisher and Reinfelder (1995).

2.4. Metal biomagnification

“Biomagnification” of metals and radionuclides in aquatic organisms refers to an increase in tissue concentration of a given element in higher trophic levels of a specific food chain. The underlying assumption is that the transfer pathway for element bioaccumulation and eventual biomagnification is through ingestion of contaminated prey. This phenomenon occurs when the assimilation efficiency of the element (i.e., transfer of the element from ingested food into the gut cells or beyond) is very high, and the corresponding element excretion rate is very low. In most aquatic food chains, the food chain transfer and resultant biomagnification pertain to element concentrations in whole organisms since rarely are only specific animal organs or tissues consumed in nature. Problems arise in the use of the term biomagnification when element concentrations in different tissues of organisms from different trophic levels are compared and found to “increase” along a specified food chain (Gray, 2002). Tissues are quite specific in their ability to accumulate metals and radionuclides, and many tissues or organs also incorporate their element burdens through direct absorption from water or translocation from other tissues. Hence, certain observed biomagnified element concentrations based on whole body or individual tissue concen-

trations of higher trophic level organisms may not at all be due to food chain transfer. An example where knowledge of uptake pathways is critical in determining the existence of metal biomagnification is plutonium transfer in the mussel-starfish food chain. Greatly enhanced plutonium concentrations observed in whole starfish feeding on mussels can lead to the conclusion that plutonium, a radionuclide that is generally poorly assimilated in invertebrates, is biomagnified. However, carefully-controlled radiotracer experiments showed that when starfish accumulated plutonium from water, the resulting radiotracer tissue distribution closely matched the natural distribution of $^{239,240}\text{Pu}$ in tissues of starfish contaminated by fallout and released nuclear wastes; such was not the case when plutonium tracer was incorporated in starfish fed contaminated mussels (Guary *et al.*, 1982).

The general public often holds the view that biomagnification of contaminants in aquatic organisms is a common occurrence in nature. In reality, for trace metals and radionuclides the phenomenon is rare and at present is only known to occur regularly for methyl mercury, radiocesium, and perhaps polonium. Methyl Hg is known to display a high assimilation efficiency and a biological half-life on the order of months to years in many marine species (Meili, this volume). This, in combination with a declining growth efficiency, may lead to an overall accumulation of Hg with age and therefore high concentrations of Hg in older, top-level predator fish and mammals. Biomagnification of ^{137}Cs has been observed in both freshwater and marine fish food chains (Rowan and Rasmussen, 1994; Zhao *et al.*, 2001) and is thought to result from the longer biological half-life of ^{137}Cs relative to its analogue element potassium in fish. Correspondingly, the biomagnification of methyl-Hg, typically threefold with each trophic transfer, can be explained by a three-fold slower elimination rate relative to the turnover of proteins, the dominant binding matrix (Meili, 1997). Other elements should also be examined for their potential to biomagnify in specific food chains. For example, very high total Cd concentrations are known to occur in certain tissues of cephalopods and their marine mammal predators, and recent experimental data demonstrate high assimilation from food and virtually no subsequent excretion of ingested Cd in cephalopods (Bustamante and Caurant, this volume). Hence, there is a clear potential for Cd to biomagnify in cephalopods and a more rigorous test of the biomagnification hypothesis in this food chain would be of considerable interest. Further, there is evidence that ^{210}Po , a naturally occurring radionuclide of considerable interest from the radiological protection standpoint, displays biomagnification in pelagic food webs (Heyraud and Cherry, 1979), consistent with recent observations that it displays high assimilation efficiencies and low afflux rates in crustacean zooplankton (Steward and Fisher, unpubl.).

2.5. Subcellular metal partitioning

As described earlier, a metal's speciation in the external (exposure) environment will affect its availability to aquatic organisms. From a chemical point of view, one might expect this influence of metal speciation to extend from the extracellular to the intracellular environment. It has in fact been hypothesised that the manifestation of metal toxicity is associated with the binding of an "inappropriate" metal to a physiologically important molecule (Mason and Jenkins, 1995); the goal of metal detoxification would then be to "protect" these physiologically important molecules by sequestering the incoming toxic metal and minimizing its intracellular bioavailability. It follows that determination of the subcellular partitioning of a metal in a particular target tissue might be a useful indicator of whether or not the host organism had been able to detoxify the metal successfully.

The subcellular partitioning of a metal may also affect its availability for trophic transfer. A prey organism with a high concentration of a particular trace metal represents a potential opportunity for the trophic transfer of the metal from an enriched source to a predator at the next trophic level. The form of detoxified storage of that accumulated trace metal in the prey species has a significant effect on the potential assimilation of that metal by the predator. For example, Nott and Nicolaidou (1990) have shown that the bioavailability to neogastropod mollusc predators of metals present in detoxified metalliferous granules in prey varies among metals and with type of granule; thus the zinc-rich pyrophosphate granules accumulated in barnacles are not digested in the digestive tract of the predator *Nucella lapillus* and are therefore not bioavailable to that predator. Similarly the physico-chemical form of accumulated cadmium in the oligochaete *Limnodrilus hoffmeisteri* is

critical in the assimilation of cadmium by a predator, in this case the decapod *Palaemonetes pugio* (Wallace and Lopez, 1997).

2.6. Modeling considerations

A mechanistic understanding of the processes involved in the uptake and accumulation of metals by aquatic organisms requires coupling of the different processes in a dynamic manner. To do this, accumulation models can be constructed that link exposure to uptake, compartmentalization and excretion. These models are powerful tools to analyze the separate events and predict the combined result of the processes in a space- and time- resolved manner. Important model input, usually determined from laboratory experiments under well-defined conditions, includes information concerning the concentrations and speciation of the metal present in the exposure media (e.g., water, sediment, food), and data on the kinetics of uptake and elimination of the metal by the organism. This requirement includes information on the feeding rates of the animals under consideration and assimilation efficiencies of the metals from food in the animals. However, once this information is obtained, a model can be used to predict uptake and accumulation under conditions and scenarios that deviate from the experimentally studied cases.

When model predictions for metal accumulation in aquatic animals have been made on a site-specific basis, they have generally matched independent field measurements for metal concentrations in those animals, as shown for marine (Wang *et al.*, 1996a; Griscom *et al.*, 2002) and freshwater bivalves (Roditi *et al.*, 2000), marine copepods (Fisher *et al.*, 2000), and fish (Baines *et al.*, 2002). The close match between model-predicted and measured metal concentration in animals suggests that (1) the laboratory-derived measurements of metal uptake/release parameters are applicable to natural waters, and (2) we can now quantitatively account for the dominant processes governing metal concentrations in marine organisms. Further, models can be used to determine the relative importance of different exposure routes for metal accumulation, the transfer of metals from one trophic level to another, and the effect of changes in exposure conditions and time on the accumulation processes (Blust, this volume).

Different types of dynamic models can be constructed, ranging from very simple one-compartment models to highly complex multi-compartment models. One-compartment models consider the organism as a single homogeneous pool with an input (uptake) and an output (elimination). More complex models incorporate more compartments so that metal uptake and internal compartmentalization are described with more detail and realism. However, the more complex a model becomes, the more information is required to parameterize it. This step requires long-term and detailed experiments and in many cases that information is not available or is difficult to obtain experimentally. Therefore it is important to consider the purpose of the models carefully and decide on that basis what degree of sophistication and resolution is required to answer the questions being addressed. In any case, it has to be realized that models are inherently (over)simplifications of the processes being simulated and that a model is only as good as the quality of the data on which the parameterizations are based and on the soundness and completeness of the assumptions underlying the model structure.

Metals can be eliminated from metabolic pathways either by excretion or by immobilization/sequestration in bones, shells, exoskeletons, or internal precipitates (e.g., Rainbow, 2002). Both uptake rates and elimination rates vary widely among metals, organisms, and environmental conditions. Elimination rates may be particularly slow if accumulation is not limited to specific organs (e.g., liver or kidney) but rather evenly distributed in a large tissue volume. Metabolic processes apparently exert a significant influence on the turnover of metals, in particular those that are predominantly stored in soft tissues, such as methylmercury and radiocesium. Relationships between the metabolism of trace substances and basic environmental parameters may thus assist in the search of general biokinetic models. Quantitative predictions of physiological and ecological kinetics can be generated from simple scaling models and basic physical data, at least to within an order of magnitude (Meili, this volume).

Recommendations

- Given the potential importance of the free metal ion as a predictor of metal bioavailability in aquatic environments, it would be helpful to compile a critical review of those approaches that

can be used either to measure the free metal ion activity or to calculate it. The review could also address the challenge of collecting marine samples without introducing inadvertent contamination.

- Information regarding the role of microorganisms (e.g., protozoa, bacteria, viruses) in the biogeochemical cycling of metals in coastal and pelagic marine systems is deficient. Metal residence times in the water column are inherently sensitive to the size, settling velocity and trophic fate of the particles with which they initially interact – in this context there is a need to quantify the importance of bacteria and viruses in controlling trace metal concentrations and fate in marine systems.
- Since net bioaccumulation of metals reflects the balance between uptake and elimination, the assessment of metal elimination is just as important as that of metal uptake for understanding variability in metal concentrations among biota. Since metal elimination is controlled by internal (physiological) processes, the link between metal turnover (pathways as well as rates) and general biological turnover patterns related to size, activity, growth, and reproduction deserves particular attention (Wang, 2002).
- The partitioning of a metal in a prey organism will influence the trophic transfer of the metal to the consuming organism. For consumers with very simple digestive strategies, the assimilation efficiency of a metal can be predicted from the physical partitioning of the metal in the prey item (i.e., the proportion of the metal that is present in the cytosol). There is a need to extend this knowledge base to include consumers with more intensive digestive strategies, and to take into account the chemical speciation of the metal in the prey.
- The knowledge base for those organisms selected for biomonitoring purposes in the Mediterranean Sea should be completed (e.g., dynamics of metal uptake and elimination, from water and food; influence of organism physiology on metal uptake and elimination; influence of seasonal physiological cycles; influence of changing environmental parameters). This has largely been done for *Mytilus galloprovincialis*, which is virtually identical to *Mytilus edulis*; and, to a lesser extent, for the sea urchin *Paracentrotus lividus* and the seagrass *Posidonia oceanica* (Warnau, this volume). However, similar data bases for other key organisms are not available.
- Modeling rates and routes of metal accumulation in marine organisms can provide a useful framework for understanding key processes and should be incorporated into designing appropriate laboratory and field studies. However, sensitivity analyses should be developed by the modelers to determine how finely measured some of the key uptake parameters (including assimilation efficiencies of metals from ingested food, absorption from the dissolved phase, and efflux rates) need to be so that laboratory experiments can become more efficient and more applicable to field conditions.

3 - ANALYTICAL CHEMISTRY CONSIDERATIONS

In natural aquatic systems, trace metals exist in different chemical forms such as the free hydrated ions, inorganic and organic complexes and metals associated with colloidal particles. The proportion of these different forms may vary continuously with space and time due to concurrently occurring physical, chemical and biological processes. As noted earlier, any variation in the speciation of an element will affect its bioavailability and its overall mobility in the aquatic system. Thus, not only total metal concentration, but also reliable measurements of trace metal speciation in the aquatic environment are essential for studies of trace metal cycling and metal bioavailability. Most of the techniques involved in such measurements (ASV, ligand-exchange/CSV, extraction on C-18 cartridges, etc.) require that analyses be completed on samples brought to the laboratory. The results obtained with these techniques will thus be affected by uncontrolled changes in temperature, pressure, pH, P_{CO_2} and $P_{\text{H}_2\text{S}}$ during sample collection, storage or treatment. Also, many of these techniques require the addition of reagents to the sample that modify the metal speciation. The development of *in situ* analytical techniques to determine the concentration of bioavailable trace substances, in particular free or labile species at high spatial and temporal resolution, could overcome such problems. Since these are often transient products of rapid transformation and equilibration processes, quantification easily leads to manipulation artifacts (i.e., contamination, losses by adsorption, change of speciation due to coagulation of colloids or microbial activity, etc.).

Most of the techniques developed or in the process of being developed for in situ measurements of trace metal speciation in aquatic environment could be divided into two main groups:

- a - Diffusional techniques, which include (i) diffusional equilibration samplers [e.g. dialysis (Hesslein, 1976) and diffusive equilibrium in thin-films – DET (Davison *et al.*, 1991)] and (ii) diffusional preconcentration samplers [diffusion gradients in thin-films - DGT (Davison and Zhang, 1994), and supported liquid membranes - SLM] (Parthasarathy and Buffle, 1994).
- b - Voltammetric techniques, which include the voltammetric *in situ* profiling system (VIP System) using either square wave anodic stripping voltammetry (SWASV) or square wave cathodic sweep voltammetry (SWCSV) – see Tercier *et al.* (1998).

All these techniques and others not mentioned here have certain advantages and limitations. All of them, typically operationally defined to at least some degree, need to be standardized and compared with each other under a wide variety of conditions. Only such well-defined techniques could help in understanding the biogeochemical cycling of trace metals, including transport, bioaccumulation, and toxicity.

Another emerging technology that may be applied as an analytical tool for better understanding metal bioaccumulation and possibly toxicity in marine protists makes use of synchrotron radiation in which target cells are bombarded with hard X-rays. The trace elements in the cells give off characteristic fluorescence patterns when exposed to the X-rays, and software is currently being developed to quantify the amount of metal in individual cells and its site of cellular deposition (Twining *et al.*, in press).

4 - MONITORING IMPLICATIONS FOR UNDERSTANDING BIOACCUMULATION PROCESSES

There was also considerable discussion during the Workshop on biomonitoring programs that consider the accumulation of metals by indicator organisms, usually in coastal waters. Indeed, many monitoring programs are based on bioindicators, using the properties of marine organisms to accumulate contaminants and rendering their measurements technically simpler than in water or sediment. There is also the assumption that levels measured in bioindicators represent an integrated value of the mean ambient load that is biologically available. The objectives of monitoring programs are oriented to provide reliable information on specific issues like human health protection, compliance to regulation standards or risk assessment. In most cases, monitoring programs are not primarily designed to investigate bioaccumulation processes *per se* but to discern spatial and temporal patterns in contaminant concentrations in the environment. However the group tried to identify information gathered from monitoring studies that could be useful in understanding bioaccumulation processes and resulting effects. The group recognizes that there is a need to include both experimentation and observation in any pursuit of understanding bioaccumulation processes. Experimentation controls confounding factors and is the best approach for studying cause-effect relationships, but always simplifies environmental conditions. Observational approaches (including monitoring and field studies) do not control simultaneous variability of many factors (including co-occurrence of a wide range of different contaminants), so cannot ascertain cause-effect relationships. It can be considered that field investigations are the best way to raise questions and draw inferences derived from the complex, natural systems.

Some aspects that have been learned from long-term monitoring programs have been characterized by on-going data interpretations:

1. Variability of pollution inputs (time and spatial scales of effects/exposure conditions).
2. Variability in important aspects of an organism's life cycle that influence bioaccumulation, e.g., condition index, protein synthesis, enzyme activity, reproductive cycle or seasonal growth dynamics in plants, and application of such information in designing/interpreting bioaccumulation experiments.
3. Relationship between bioaccumulation and biological effects along gradients (e.g., enzymatic biomarkers, fertilization capacity, reproductive maturity, immune defenses, population dynamics, etc.).
4. Relationships between inputs to the coastal zone and temporal trends in indicator organisms on a broad scale (e.g., Pb, ¹³⁷Cs, ⁶⁰Co, ¹⁰⁶Ru).

5. Flux measurements in complicated circumstances and inferring significance of proposed phenomena in the field (fecal transport from mussel feces to sediment; metal depletion from the water column).

Monitoring programs provide the following opportunities to learn about bioaccumulation through :

1. Understanding dynamic interactions between natural environmental changes (e.g., season) and bioaccumulation and biomarkers.
2. Observation of responses to cumulative effects or responses to multiple pollutants; spectral and multivariate analyses (e.g., multiple regression or principal component analyses) can help draw inferences from such complex data sets (Sanchiz *et al.*, this volume); analyses of single variable plots can be used to better understand responses that are characteristic of each group of variables.
3. Evaluation of simultaneous responses of batteries of monitoring variables (both in terms of bioaccumulation and biological effects through biomarkers; Odzak, this volume; Moukrim, this volume) in different types of circumstances to identify natural variability (both dynamically stable and stochastic characteristics).
4. Monitoring observations in space (along gradients) and time (after a pulse contamination event) provide excellent opportunities to study/understand bioaccumulation processes, to link bioaccumulation to effects or to test conceptual and quantitative bioaccumulation models (e.g., response to the Chernobyl accident).
5. Monitoring over a long period of time can equate to a controlled experiment, if one variable (e.g., contaminant concentration) changes unidirectionally and characteristics of the natural system do not (e.g., observations over time of a “hot spot” during remediation processes; Hornberger *et al.*, 2000); it then allows inferring effects at any level of biological organization, including those that cannot be realistically (time-scale) investigated in the laboratory (e.g., biological cycles such as reproduction, population and community levels) (Luoma, this volume).
6. Validation of theories developed from laboratory experiments under chronic exposure and complex environmental conditions.
7. Demonstration of differences in bioaccumulation processes and sensitivity to metal contaminants among species; this can lead to understanding which species are most valuable as biomonitors of bioavailable metal concentrations in the environment (i.e., which are most responsive to metal bioavailability), and which species (not necessarily the same) are the best bioindicators of contaminant effects (Luoma, this volume).
8. Test of relationships between proposed measures of bioavailability and actual bioaccumulation responses under complex environmental conditions, including using species difficult to study in the laboratory.
9. Use of conservative tissues to assess long-term trends and/or supplement real time monitoring data (through dating invertebrate skeletons or fish otoliths, lepidochronology in the seagrass *Posidonia oceanica*; Warnau, this volume).

Recommendations

The group suggested a number of recommendations that would improve future research and interpretation of bioaccumulation/monitoring data:

1. There should be a better standardization in the use of monitoring organisms and biomarkers (e.g., homogeneity in sampling and methodologies, quality control of analytical procedures).
2. It was considered that a multi-species approach would be useful to cover a wider range of bioindicative information related to the different compartments of the environment (dissolved phase, suspended particulate matter, sediments); selection of species should take into account their geographical distribution and abundance as well as their ability to accumulate the contaminants of concern (Luoma, this volume; Warnau, this volume).
3. Better advantage should be taken of field studies, in particular along gradients or in “hot spots,” to relate metal concentrations with biomarkers in indicator species used in monitoring studies.

4. Monitoring programs could be designed to improve the interpretative power of the data collected (e.g., addition of relevant ancillary parameters, selection of bioindicators representing well identified trophic levels, etc).
5. Monitoring programs could focus on a battery of valuable biomarkers of exposure and effects and need to develop an algorithm to calculate an integrated stress index (Viarengo, this volume).
6. Monitoring programs should, where possible, be combined with field experiments; such efforts specifically can give better insights into bioaccumulation mechanisms or different problems recognized from the monitoring set of data or laboratory experiments. An example of such experiments is the use of transplanted organisms or *in situ* mesocosms where accumulation is performed under more controlled but still complex environmental conditions (Thébault, this volume).
7. New conceptual models should be developed to consider complex situations, taking into account interactions among different contaminants, including non-metal contaminants in bioaccumulation processes, and subsequent biological effects.

5 - TOXICOLOGICAL CONSIDERATIONS

Research in recent years has shown clear evidence for interactions between trace metal accumulation, homeostatic and detoxification mechanisms, and metal interference with specific metabolic pathways and cell functions.

It is generally accepted that when minimal or physiological amounts of metal cations penetrate into the cells, they are rapidly bound by specific cytosolic ligands such as reduced glutathione (GSH), metallothionein or phytochelatin; metals can also be compartmentalized in lysosomes and granules. Only when the metal uptake rate exceeds the ability of the homeostasis / detoxification systems to process these metals is toxicity evident (Fig. 6). Under such circumstances, these excess metal cations react with cellular components such as enzymes and interfere with metabolic function. The relative importance of specific ligands and detoxification pathways and occur-

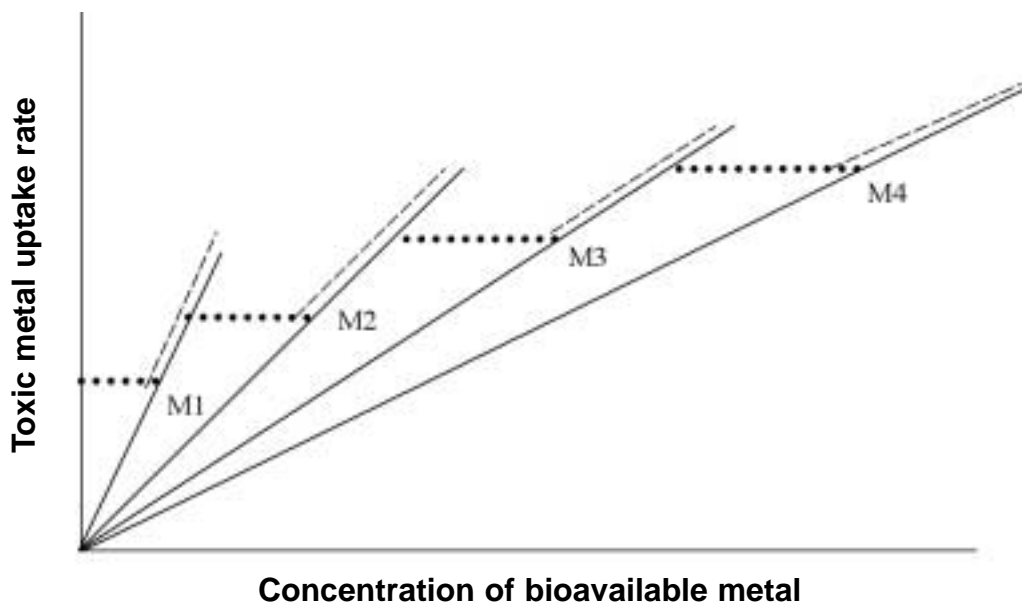

Fig.6. Hypothetical relationship between toxicity of different metals (M1...M4) in an organism as a function of ambient bioavailable metal concentration. The solid lines depict the uptake rates of the metals into the organism, the dotted lines indicate the tolerance limit of the organism for each metal, and the dashed lines indicate toxicity of the metal when the tolerance limits are exceeded for each metal. Note that the tolerance limit is achieved when the rate of metal uptake just equals the maximum detoxification (sequestration plus excretion) rate; when the uptake rate exceeds the detoxification rate, toxicity is exerted. In the figure shown, M1 would be the most toxic metal, M4 the least toxic. The relative toxicities (LC_{50} or EC_{50}) of the metals would be expected to correlate with their affinities for sulfur ligands (Shaw, 1954), with M1 having the strongest affinity and M4 the weakest affinity.

rence of toxicity responses vary in different cells, tissues and species. Further, both intrinsic and extrinsic factors such as changes in the physiological status in relation to season, age, phase of reproductive cycle, etc., all can affect toxic response. Further complicating matters, it is now recognized that synergistic and antagonistic effects can occur with other metals or classes of pollutants. Notwithstanding the complexity of such phenomena, research developed in the past years has elicited some critical aspects of biological effects of pollutants, allowing the characterization of several cellular responses (biomarkers) that can be used to reveal both the exposure and the deleterious effects caused by these contaminants.

As an important pathway of cellular perturbation induced by trace metals, the imbalance between pro-oxidant forces and anti-oxidant defenses leading to enhanced reactive oxygen species (ROS) production and oxidative stress has been pointed out. Different mechanisms and cell interactions can induce similar alterations, including (a) the binding of some metals to sulfhydryl groups of amino acids and proteins, thus altering the redox cellular potential; (b) the impaired functioning of molecules involved in maintaining the redox potential such as the alterations of enzymatic activities related to ROS removal; (c) elements like Fe and Cu also enhance the intracellular generation of oxyradicals acting as catalysts of Fenton-like reactions. Thus, Cu has been shown to induce ROS-mediated damage at the cytoplasmic and at the nuclear level; in the latter case, a clear effect of DNA oxidative damage was demonstrated.

In addition, data are now available showing the effect of trace metals on different aspects of signal transduction pathways, such as the tyrosine kinase cascade, calcium and cAMP, which can explain numerous cellular responses related both to detoxification and appearance of toxic effects at different cellular levels. In this regard, it has been demonstrated that the mechanisms of destabilization of lysosomal membrane, an early event in the activation of lysosomal macromolecular catabolism, is dependent on the free calcium levels and on the activation of Ca-dependent phospholipase A2. This finding may represent the basis for the interpretation of heavy metal effects on the lysosomal vacuolar system, taking into account that it was demonstrated that Hg, Cd and Cu are able to increase free cytosolic calcium concentration in the cells of different marine organisms when present in seawater at nanomolar concentrations.

New tools to better study the biological responses to bioaccumulated metals are emerging in the field of molecular ecotoxicology. Among these, genomics and proteomics play a key role in the evaluation of mRNA and protein profiles that can characterize the functional state of cells and tissues. The possibility to detect variations induced by trace metals on these cellular processes would represent a fundamental step toward the assessment of metal molecular interactions and their involvement in detoxification and toxicity pathways. In this regard, a mini microarray (containing 25 genes related to stress response) has been specifically developed for marine mussels, and will be soon available for both basic research and application in field biomonitoring programs (Viarengo, this volume).

Monitoring programs using so-called sentinel organisms to monitor the marine environment may provide the opportunity to relate metal concentrations to the appearance of potentially deleterious biological effects using biomarkers. A battery of biomarkers (both of stress and exposure) suitable to identify the biological effects attributable to metals is needed. International biomonitoring / research programs, such as MEDPOL and RAMOGE, have found common agreement in the selection of biomarkers to be used for early detection of toxic responses. These core biomarkers should be reviewed in the coming years, taking into account the results of a European-scale project (BEEP, Biological Effects of Environmental Pollutants) that is primarily devoted to this issue.

Recommendations

Given the difficulties in evaluating simultaneous variations of different biomarkers in large biomonitoring programs, it would be appropriate to develop in the near future an algorithm suitable to rank the stress syndrome of monitoring organisms on the basis of changes observed in analyzed biomarkers. It is also recommended that the choice and analysis of biomarkers be standardized among the various biomonitoring programs established for assessing the quality of coastal waters.

6. CLOSING COMMENTS - FURTHER DIRECTIONS FOR RESEARCH

In the course of the workshop discussions, the group noted that important advances have been made in understanding (a) the relationship of metal speciation with bioavailability and passage

across biological membranes, (b) the trophic transfer of metals in marine food webs; (c) the resulting fluxes of metals mediated by organisms in ocean systems; (d) the resulting patterns of toxic responses of organisms to accumulated metals; and (e) the application of biomonitoring programs toward extending the conclusions of laboratory-based studies of metal bioaccumulation toward “real-world” field situations. However, it was felt that more work was needed in areas that have only just begun to receive attention. In addition to the recommended research directions noted above, other priorities include:

1. gaining a better understanding of the mechanisms and rates by which atmospherically delivered metals become bioavailable to marine phytoplankton;
2. examining the interactions of metals with so-called “microbial loop” food webs in general and bacterioplankton and heterotrophic nanoflagellates in particular;
3. evaluating the influence of metal uptake routes on subsequent toxicity in animals; and
4. assessing the effects of multiple metals and/or metals and other contaminants on toxicity in marine organisms.

This synthesis, coordinated and edited by Nick S. Fisher, was initiated during the Ancona meeting and prepared by all the workshop participants.

1 - INTRODUCTION

The workshop was held from 27 to 30 October 2002 in Ancona, a busy port in the Marches region on the Italian Adriatic coast. The workshop was hosted by the Istituto di Ricerche sulla Pesca Marittima (IRPEM), through the kind assistance of its Director, Dr. Antonio Artegiani, who serves as National Representative of Italy on the CIESM Board. Eighteen scientists (see list at the end of this volume) participated at the invitation of CIESM.

In their opening remarks, Prs Frederic Briand and Nicholas Fisher, Director General of CIESM and Chair of its Marine Biogeochemistry Committee respectively, provided the overall philosophy behind such research workshops. They encouraged the participants to avoid a simple review of their own work or of the field in general, recommending instead that discussions aim to produce a constructive synthesis and critique of the major developments in the area of metal/radionuclide bioaccumulation in marine organisms together with some recommendations for future work in this broad and growing field.

Bioaccumulation (defined here as association of a metal with an organism) is a necessary first step before organisms can manifest a response to metals or influence metal geochemical cycling. Many studies have been conducted in recent years to evaluate the rates and mechanisms of metal bioaccumulation in marine organisms. These studies have been motivated in part by a number of practical issues, such as public health concerns arising from the consumption of contaminated seafood, a need to establish improved water or sediment quality criteria in coastal regions, and risk assessment exercises (for both marine communities and human populations) which require information on bioconcentration factors for contaminants in diverse marine organisms. Risk assessments have been particularly applied to long-lived components of radioactive wastes emanating from the nuclear fuel cycle, most of which are metals. However, there is also considerable interest in understanding metal accumulation in marine organisms as they can greatly influence the cycling, fluxes, and residence times of metals/radionuclides in marine systems. Moreover, the recognition that low concentrations of some essential metals in a bioavailable form can be limiting to some marine organisms, most notably iron to phytoplankton in high nutrient, low chlorophyll (HNLC) areas of the oceans, has spurred many recent studies on relating metal speciation in water to bioavailability and metal accumulation to metabolic responses.

The short papers that follow in this volume consider such matters as (1) relating metal speciation (chemical and physical) to metal bioavailability to marine organisms; (2) environmental (or external) and physiological (internal) controls of metal fluxes through marine organisms; (3) evaluating the significance of metal uptake by organisms for understanding metal fluxes and residence times in oceanic systems; (4) relating biological responses (e.g., growth, toxicity) to pathways of metal uptake; (5) biochemical distributions of metals in marine organisms and their implications for metal toxicity and trophic transfer; and (6) modeling metal bioaccumulation in marine organisms and an evaluation of its appropriateness to understanding metal concentrations in marine organisms.

A number of publications have presented organizing principles by which the fate and effects of broad classes of metals can be understood and predicted in marine systems. These include geochemical considerations (Whitfield and Turner, 1987), general biological interactions (Nieboer

and Richardson, 1980), including bioaccumulation in marine organisms (Williams, 1981; Fisher, 1986) and toxicological effects (Shaw, 1954; Kaiser, 1980; Nieboer and Sanford, 1985). The advantages and limitations of these broad groupings of metals based on properties of the metal ions themselves were discussed by Rainbow (1997a), who focused on metal interactions with marine invertebrates. Despite some limitations, such generalizations were considered useful and sometimes provided penetrating insights into the nature of metal binding to, or effects on, marine organisms. They helped form the framework for the discussions of this Workshop which considered the processes governing metal bioaccumulation in marine organisms including analytical, monitoring, and modeling tools for studying these processes, and the geochemical and biological consequences of this accumulation.

2 - METAL BIOAVAILABILITY

2.1. Speciation effects in solution

Laboratory and field observations clearly indicate that the total concentration of a metal, in solution (“dissolved” metal) or associated with particles (“particulate” metal), is rarely a good predictor of metal bioaccumulation or toxicity in aquatic organisms. On the other hand, environmental geochemists have demonstrated that metals exist in a variety of physical and chemical forms in the water column and in the bottom sediments. Faced with these general observations, environmental scientists and managers have rather uncritically accepted the notion that some fraction of the total metal concentration is “bioavailable”. There is no doubt that this statement is qualitatively correct, but it has proven difficult to develop a universally applicable quantitative definition of “bioavailability”. Two major factors contribute to this dilemma: (i) the diversity of routes by which metals may in fact be bioaccumulated by aquatic organisms, and (ii) the dynamic nature of metal speciation (and the analytical limitations to measuring this speciation).

With respect to the first factor, one can make a useful first distinction between those organisms that are exposed only to dissolved metals, e.g. bacterioplankton, phytoplankton cells, or macrophytes, and those that are exposed both to dissolved metals and to metals that are incorporated into their ingested food, e.g. protozoa, zooplankton and higher herbivores / carnivores. However, even within these classes there will exist a wide variety of routes of metal uptake. For example, even for a simple unicellular alga (Fig. 1), metals may enter the cell by facilitated cation transport, by facilitated anion transport and by passive diffusion of lipophilic metal forms; the relative importance of these uptake pathways will vary from one algal cell to another. Similarly, while similar transport systems will exist at gill and intestinal epithelia, the relative importance of the different uptake

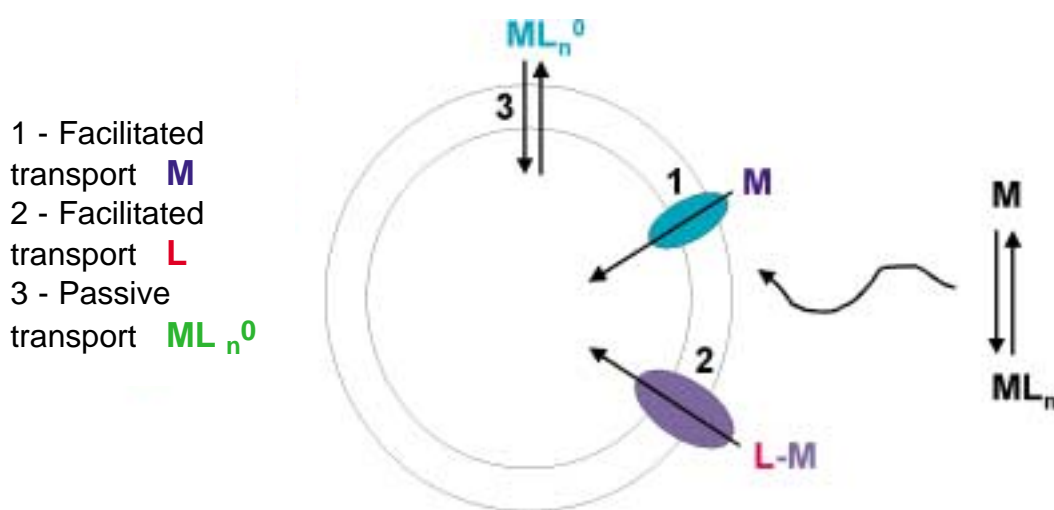

Fig. 1. General scheme showing how metals may enter living cells: (1) carrier-mediated cation transport and/or cation-channel transport; (2) carrier-mediated transport of metal-ligand anionic complexes; (3) passive transport of lipophilic metal forms.

routes will vary from one biological interface to another. In addition, in a given aquatic environment the indigenous organisms will tend to occupy different (micro)habitats; if the chemical conditions (e.g., $[O_2]$, pH, pCl, [dissolved organic matter]) in these microhabitats differ, then metal speciation and bioavailability will also vary from one microhabitat to another within the given (macro)environment. For both these reasons (different routes of exposure to metals and different physiologies; different microhabitats), it follows that even in a defined aquatic environment, metal “bioavailability” will not be a constant property of the system but will tend to vary from one organism to another.

The influence of the second factor, i.e. the dynamic nature of metal speciation, is perhaps a little more subtle. In most cases, the distribution of a metal among its various chemical forms (see Fig. 2) is very rapid. Under such circumstances, if one particular metal form is taken up from the exposure solution (e.g., the free metal ion), its concentration will decrease only transiently; the external equilibria will immediately adjust to replenish the metal form that has been taken up. Laboratory experiments suggest that this general scenario is often played out in just this manner. If this is the case, the free metal ion activity will be the best predictor of metal uptake from solution, but it cannot legitimately be described as the “bioavailable form” of the metal because, in fact, all of the forms in equilibrium with the free metal ion are contributing to the uptake flux by maintaining the external free ion concentration/activity.

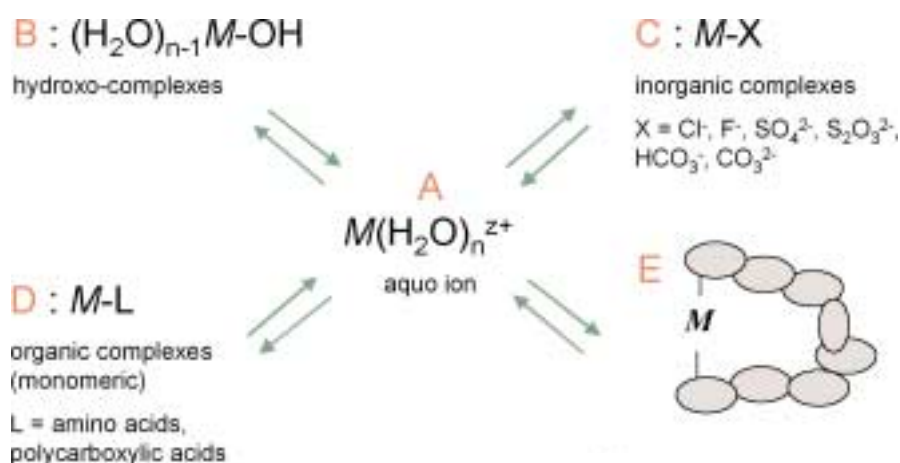

Fig. 2. Examples of metal “species” found in natural waters.

Trace metals are taken up by aquatic organisms from solution across the cell membrane of permeable surfaces by one or more transport routes (Blust; Campbell; Rainbow, this volume), including:

- a) carrier-mediated transport whereby a metal ion binds with a membrane protein;
- b) a membrane channel consisting of a protein with a hydrophilic core through which metal ions are transported, perhaps to be considered as a variant of the carrier protein route;
- c) passive diffusion of lipid-soluble (non-polar) metal forms which dissolve in the lipid bilayer, including alkyl-metal compounds and neutral, lipophilic, inorganically complexed metal species (e.g., $HgCl_2^0$);
- d) endocytosis when a region of the cell membrane invaginates to engulf a metalliferous particle for transfer into an intracellular vesicle.

Once trace metals cross the cell membrane, their binding with non-membrane permeable cytosolic proteins of higher affinity for the metal ensures that they continue to enter passively, even though the internal concentration of total metal in the cell is higher than the external dissolved metal concentration. Major ions like Na^+ and K^+ do not have such high affinities for complexing agents,

including proteins, and remain relatively uncomplexed in the intracellular environment; maintenance of the concentration gradients for these metal ions may require the use of energy, e.g., involvement of membrane-bound ATP-ases.

2.2. Metal bioavailability from food sources

As mentioned above, it is generally considered that the free metal ion is available for transport across the cell membrane via a carrier protein or through a membrane channel, and therefore the free metal ion will often be the best predictor of uptake of metal from the dissolved phase (Campbell, this volume). Whereas organisms positioned at the bottom of the food web such as unicellular algae take up metals exclusively (or predominantly) from the dissolved phase (with the exception of rooted plants), organisms positioned at higher trophic levels are exposed via other routes including suspended matter, sediment particles and different food sources. This creates a more complex situation so that the relationship between the free metal ion concentration and metal uptake may be lost.

Inside an organism, metals are distributed among different compartments, of which some are strong accumulators (e.g., liver and kidney) and others are much weaker accumulators (e.g., muscle tissue). Inside the cells of the tissues the metals are bound to different types of ligands and partitioned into exchangeable (or labile) and non-exchangeable (or inert) metal pools. Thus, inside an organism metals occur in various compartments and forms, the chemical speciation of which is very different from that in the external environment. Feeding involves the ingestion and digestion of food items (which may include suspended or deposited sediment particles). Depending on their physiology and position in the food web, organisms have developed different feeding and digestion strategies. This also means that the way in which the metals are processed during the digestion process may be very different, resulting in potentially large differences in metal assimilation efficiencies. Several studies have indeed shown that assimilation efficiencies of metals from food strongly depend on food preference, feeding strategy, and digestive physiology. Hence, a direct relationship between the free metal ion concentration in the exposure solution and metal uptake by an animal will only be found when (i) uptake via water is the predominant exposure route, or (ii) the concentrations of the metals present in the food items are proportional to the ambient free metal ion activity, and assimilation efficiency is invariant across different milieus.

In addition, aquatic organisms have developed different strategies to deal with metals. Some metals are essential nutrients for which the body or tissue concentrations are more or less under homeostatic control (e.g., copper or zinc), whereas others are not essential and do not appear to be regulated very strongly (e.g., cadmium or mercury). Regulation can occur in two different ways, either by matching metal excretion to metal uptake so that the internal body concentration of the metal remains constant, or by storing part of the metal in a physiologically inactive pool. Aquatic organisms employ both strategies and in many cases effective regulation and/or detoxification is achieved by combining the two methods. Together with the relative importance of different exposure routes, these differences in internal processing explain why there can be important differences in body metal concentrations and internal metal speciation among organisms from the same environment.

2.3. Biogeochemical oceanographic considerations

To this point we have emphasized the influence of chemical speciation of trace metals on metal bioavailability. The physical speciation of metals can also strongly influence their fate and behavior in marine ecosystems. Thus, metals that show little binding to particulate matter in marine systems (i.e., conservative metals such as uranium or technetium) will be relatively unavailable for uptake by marine herbivores through trophic transfer since there will be little or no uptake of these metals from the dissolved phase into the phytoplankton food. Further, the cycling and fluxes of these metals will not be affected by particles, and hence their oceanic residence times approach that of the water itself.

Many metals do however associate to varying extents with particulate matter and these metals can be accumulated in animals both from ingested particulate matter (i.e., food) as well as from the dissolved phase. The fluxes of these metals are strongly influenced by particle flux, including biogenic particles such as sinking fecal pellets or phytodetritus, which are highly enriched in

metals (Fowler, 1982; Fowler and Knauer, 1986), and abiotic particulate matter. The most particle-reactive metals have oceanic residence times approaching those of the particles themselves. Their residence times in the ocean, and most particularly in surface waters, tend to be very short and have been shown to be closely related to the metal concentration factor in sinking biodebris (Cherry *et al.*, 1978). Many particle-reactive metals are Class A metals, which have a high affinity for oxygen ligands; examples include thorium, aluminium, plutonium, and many of the lanthanides (Whitfield and Turner, 1987). By size-fractionating metals in surface seawater, it can be shown that some metals presumed to be “dissolved” (i.e., they would pass through a 0.2 or 0.45 μm filter) are, in fact, bound to colloidal particles, operationally defined as suspended material that behaves like particles but is smaller than the common “cut-off” for particulate matter (either 0.2 or 0.45 μm). Many of these Class A, particle-reactive metals show appreciable and rapid binding to colloidal particulate matter, probably because of the very high surface to volume ratios of these very small particles and possibly because, as well, there are numerous oxygen-containing binding groups on the surfaces of these colloids to which the metals can bind. Subsequently, these colloidally-bound metals can associate with larger particles such as phytoplankton cells via particle-particle interactions (Honeyman, 1991). Such colloidally delivered metals cannot easily be transported into the cytoplasm of cells, either by carrier proteins or enzymatic action, and as well would have relatively little chance of diffusing across the cell membranes into the cytoplasm because these metals are not, for the most part, bound directly to the cell surface but rather to colloidal matter which in turn is bound to cell surfaces.

Thus, these metals are often found associated with the surfaces of microbial cells, generally showing little penetration into the cytoplasm of these cells. Consequently, when these cells are eaten by herbivores, these surface-bound metals display little assimilation into the tissues of the herbivores and get released from the animals packaged into fecal pellets. Cytoplasmically distributed metals tend to be assimilated into the tissues of herbivores; generally, a very tight relationship has been observed between assimilation efficiencies of ingested trace metals and the cytoplasmic distribution of these elements for herbivores (e.g., copepods, bivalve larvae) with relatively simple guts and short gut transit times (Fig. 3). Note that the slope of the regression shown in Figure 3 is

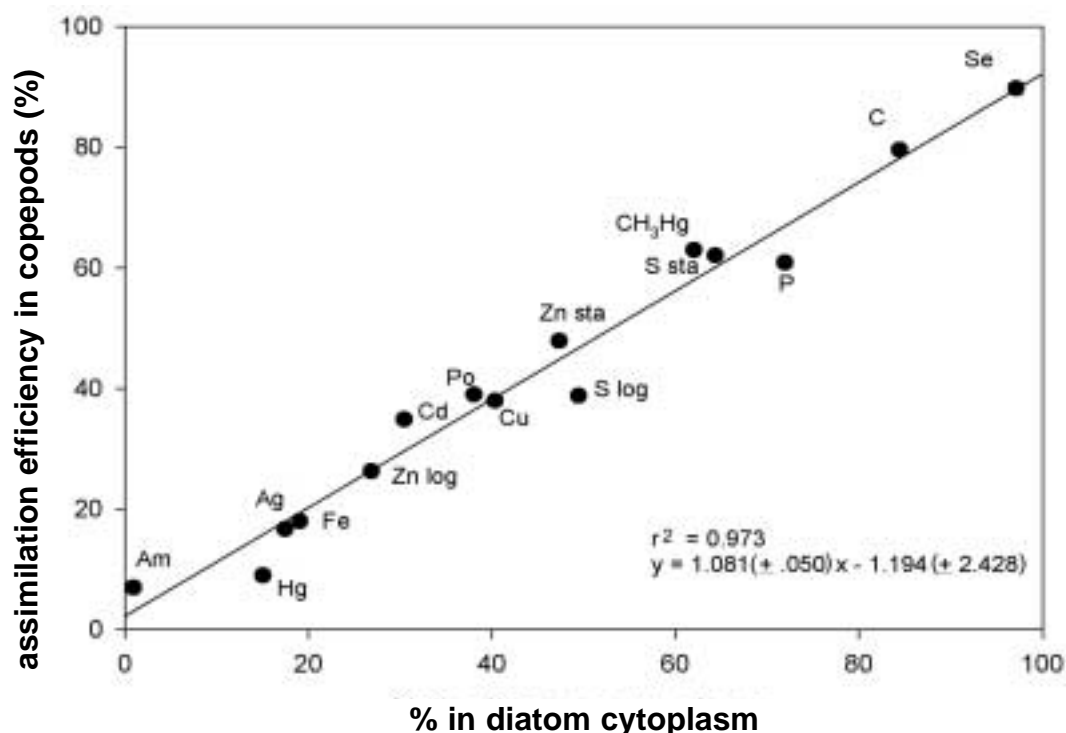

Fig. 3. Relationship between assimilation efficiency (%) of ingested elements in marine copepods and their cytoplasmic distribution in the diatom (*Thalassiosira* spp.) prey. For S and Zn, both stationary phase (sta) and log-phase (log) diatom cultures were examined. Data from Reinfelder and Fisher (1991), Hutchins *et al.* (1995), Mason *et al.* (1996), Sung and Reinfelder (2000), and Stewart and Fisher (unpubl.).

not significantly different from 1 and the intercept not different from 0. The relationship displayed in Fig. 3 between assimilation efficiency of ingested metals in zooplankton and the cytoplasmic distribution of metals in the phytoplankton food is remarkably robust and holds for both essential and non-essential elements. The data for this Figure, compiled for this report from various recent studies, clearly indicate that the assimilation of ingested metals by zooplankton can be predicted based on the distribution of metal in the food. This correlation between cellular distribution in the food and assimilation efficiency in the herbivore is still apparent but considerably less robust for animals with longer gut residence times and more complicated guts (e.g., adult mussels). Fecal pellets produced by pelagic zooplankton can often sink at rates of 50-150 m day⁻¹ (Turner, 2002); hence these metals get transferred rapidly into deeper waters or even sediments. Further, because these particle-reactive metals typically display little assimilation into animal tissues, they show little build-up in marine food chains. Since the resulting concentrations of these metals in marine animals are relatively low due to this low assimilation, these metals would not be expected to exert any toxic action on marine animals nor would they likely pose a public-health problem for human consumers of seafood.

It is noteworthy that even the most particle-reactive metals are predominantly in the dissolved (or colloidal) phase in most marine waters (Fig. 4). This observation simply reflects the fact that suspended particle loads in seawater tend to be low, rarely exceeding 10 mg L⁻¹ in surface waters, and often in the 0.1-2 mg L⁻¹ range. In turbid estuaries, however, particle loads can be quite high (this loading varies enormously among estuaries and with season), and in these systems a concomitantly greater proportion of the total metal will be associated with particulate matter.

In contrast to the Class A cations, many of the transition metals show intermediate or even high reactivity for particulate matter but negligibly small association with colloidal matter in seawater. These metals may bind to cell surfaces directly, and therefore can get transported to a greater extent into the cytoplasm of phytoplankton cells. When these cells are eaten by herbivores, these

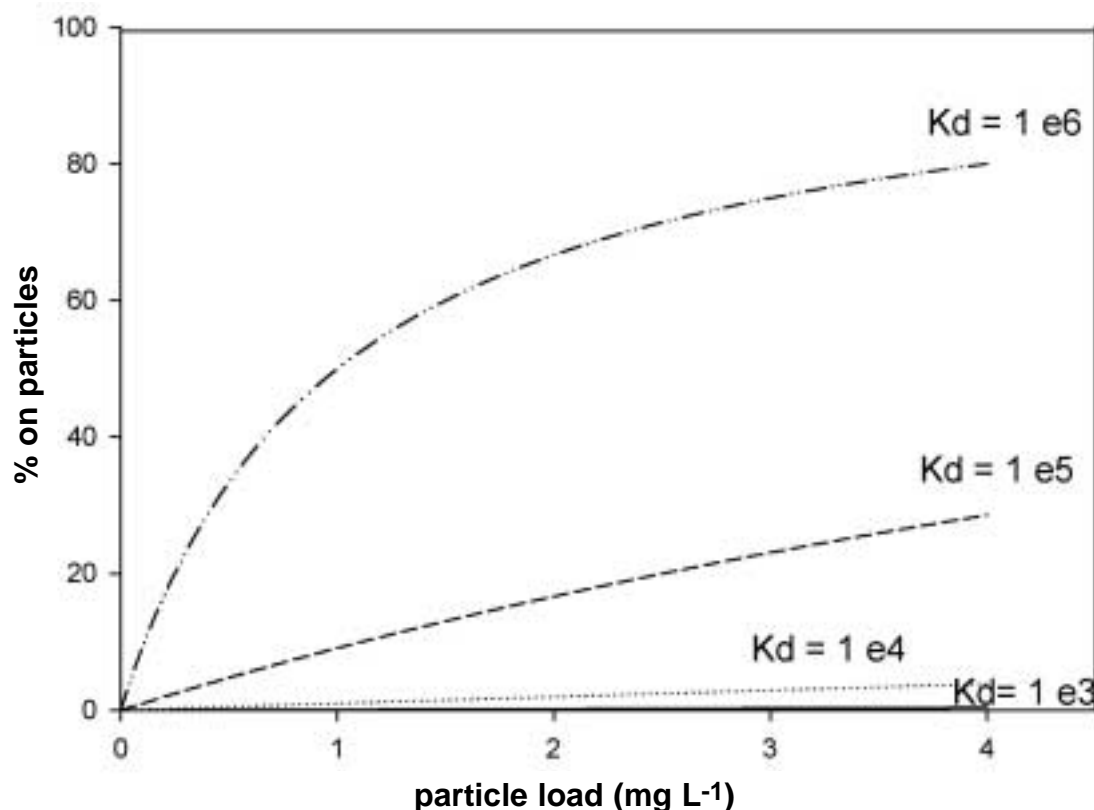

Fig. 4. Calculated partitioning of metals with K_d s (equal to dry wt. concentration factors) ranging from 10^3 to 10^6 on to particles over a suspended particulate load range of 0 to 4 mg L⁻¹. Note that for typical surface seawater particle loads (≈ 1 mg L⁻¹), even the most particle-reactive metals are predominantly in the dissolved phase. Most metals have K_d s $< 10^5$ (Fisher, 1986).

cytoplasmically associated metals get assimilated into the animal tissue, have a chance to build up to appreciable concentrations in the tissues of marine animals, and thus may pose a threat either to these animals (toxicity) or to human consumers. Because these metals become more closely associated with the carbon cycle, they get recycled biologically by organisms, and consequently display longer oceanic residence times (Fig. 5). Thus, metals display a positive relationship between assimilation efficiencies in zooplankton and oceanic residence times and an inverse relationship between concentration factors in phytoplankton (or any particles) and oceanic residence times.

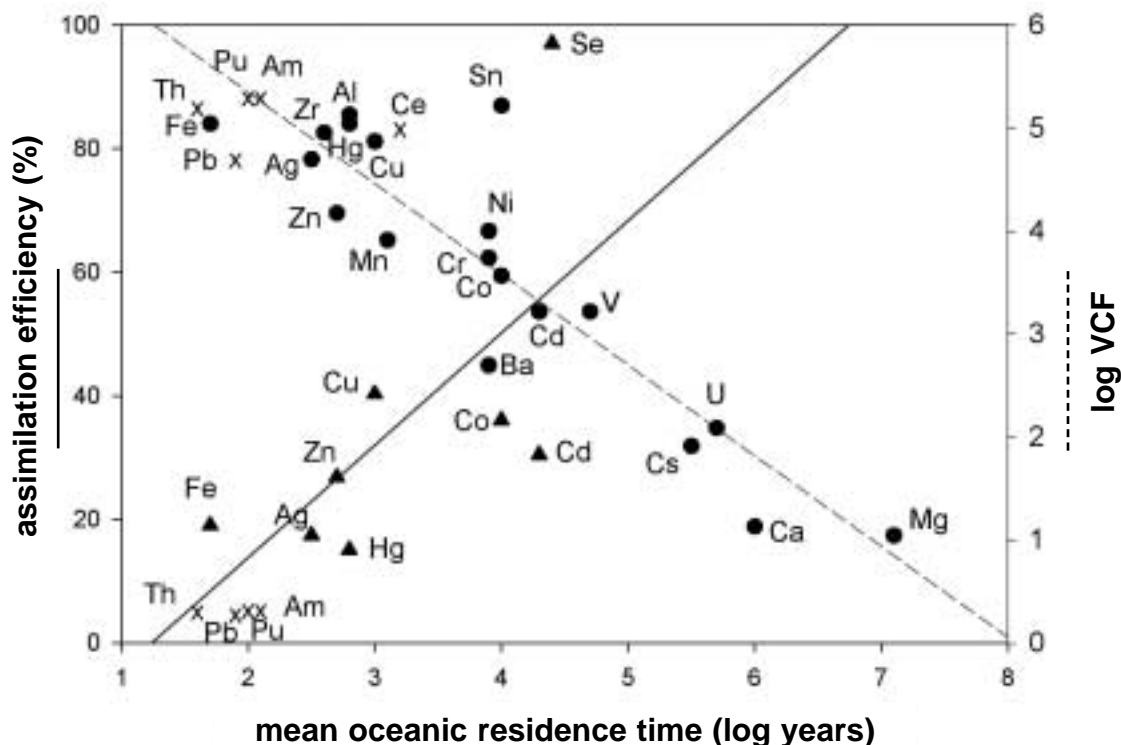

Fig. 5. Relationship between assimilation efficiency (%) of ingested metals in marine copepods (left y-axis) and mean oceanic residence times of the metals (log years) (triangles connected by solid line, $y = 18.15 (\pm 8.48) x - 22.4 (\pm 27.9)$; $r^2 = 0.621$); relationship between log volume concentration factor (VCF, right y-axis) of metals in phytoplankton and mean oceanic residence time of the metals (circles connected by dashed line, $y = -1.014 (\pm 0.114) x + 7.276 (\pm 0.474)$; $r^2 = 0.835$). Note: elements denoted by "x" associate appreciably with colloidal matter in seawater. Adapted from Fisher (1986) and Fisher and Reinfelder (1995).

2.4. Metal biomagnification

“Biomagnification” of metals and radionuclides in aquatic organisms refers to an increase in tissue concentration of a given element in higher trophic levels of a specific food chain. The underlying assumption is that the transfer pathway for element bioaccumulation and eventual biomagnification is through ingestion of contaminated prey. This phenomenon occurs when the assimilation efficiency of the element (i.e., transfer of the element from ingested food into the gut cells or beyond) is very high, and the corresponding element excretion rate is very low. In most aquatic food chains, the food chain transfer and resultant biomagnification pertain to element concentrations in whole organisms since rarely are only specific animal organs or tissues consumed in nature. Problems arise in the use of the term biomagnification when element concentrations in different tissues of organisms from different trophic levels are compared and found to “increase” along a specified food chain (Gray, 2002). Tissues are quite specific in their ability to accumulate metals and radionuclides, and many tissues or organs also incorporate their element burdens through direct absorption from water or translocation from other tissues. Hence, certain observed biomagnified element concentrations based on whole body or individual tissue concen-

trations of higher trophic level organisms may not at all be due to food chain transfer. An example where knowledge of uptake pathways is critical in determining the existence of metal biomagnification is plutonium transfer in the mussel-starfish food chain. Greatly enhanced plutonium concentrations observed in whole starfish feeding on mussels can lead to the conclusion that plutonium, a radionuclide that is generally poorly assimilated in invertebrates, is biomagnified. However, carefully-controlled radiotracer experiments showed that when starfish accumulated plutonium from water, the resulting radiotracer tissue distribution closely matched the natural distribution of $^{239,240}\text{Pu}$ in tissues of starfish contaminated by fallout and released nuclear wastes; such was not the case when plutonium tracer was incorporated in starfish fed contaminated mussels (Guary *et al.*, 1982).

The general public often holds the view that biomagnification of contaminants in aquatic organisms is a common occurrence in nature. In reality, for trace metals and radionuclides the phenomenon is rare and at present is only known to occur regularly for methyl mercury, radiocesium, and perhaps polonium. Methyl Hg is known to display a high assimilation efficiency and a biological half-life on the order of months to years in many marine species (Meili, this volume). This, in combination with a declining growth efficiency, may lead to an overall accumulation of Hg with age and therefore high concentrations of Hg in older, top-level predator fish and mammals. Biomagnification of ^{137}Cs has been observed in both freshwater and marine fish food chains (Rowan and Rasmussen, 1994; Zhao *et al.*, 2001) and is thought to result from the longer biological half-life of ^{137}Cs relative to its analogue element potassium in fish. Correspondingly, the biomagnification of methyl-Hg, typically threefold with each trophic transfer, can be explained by a three-fold slower elimination rate relative to the turnover of proteins, the dominant binding matrix (Meili, 1997). Other elements should also be examined for their potential to biomagnify in specific food chains. For example, very high total Cd concentrations are known to occur in certain tissues of cephalopods and their marine mammal predators, and recent experimental data demonstrate high assimilation from food and virtually no subsequent excretion of ingested Cd in cephalopods (Bustamante and Caurant, this volume). Hence, there is a clear potential for Cd to biomagnify in cephalopods and a more rigorous test of the biomagnification hypothesis in this food chain would be of considerable interest. Further, there is evidence that ^{210}Po , a naturally occurring radionuclide of considerable interest from the radiological protection standpoint, displays biomagnification in pelagic food webs (Heyraud and Cherry, 1979), consistent with recent observations that it displays high assimilation efficiencies and low afflux rates in crustacean zooplankton (Steward and Fisher, unpubl.).

2.5. Subcellular metal partitioning

As described earlier, a metal's speciation in the external (exposure) environment will affect its availability to aquatic organisms. From a chemical point of view, one might expect this influence of metal speciation to extend from the extracellular to the intracellular environment. It has in fact been hypothesised that the manifestation of metal toxicity is associated with the binding of an "inappropriate" metal to a physiologically important molecule (Mason and Jenkins, 1995); the goal of metal detoxification would then be to "protect" these physiologically important molecules by sequestering the incoming toxic metal and minimizing its intracellular bioavailability. It follows that determination of the subcellular partitioning of a metal in a particular target tissue might be a useful indicator of whether or not the host organism had been able to detoxify the metal successfully.

The subcellular partitioning of a metal may also affect its availability for trophic transfer. A prey organism with a high concentration of a particular trace metal represents a potential opportunity for the trophic transfer of the metal from an enriched source to a predator at the next trophic level. The form of detoxified storage of that accumulated trace metal in the prey species has a significant effect on the potential assimilation of that metal by the predator. For example, Nott and Nicolaidou (1990) have shown that the bioavailability to neogastropod mollusc predators of metals present in detoxified metalliferous granules in prey varies among metals and with type of granule; thus the zinc-rich pyrophosphate granules accumulated in barnacles are not digested in the digestive tract of the predator *Nucella lapillus* and are therefore not bioavailable to that predator. Similarly the physico-chemical form of accumulated cadmium in the oligochaete *Limnodrilus hoffmeisteri* is

critical in the assimilation of cadmium by a predator, in this case the decapod *Palaemonetes pugio* (Wallace and Lopez, 1997).

2.6. Modeling considerations

A mechanistic understanding of the processes involved in the uptake and accumulation of metals by aquatic organisms requires coupling of the different processes in a dynamic manner. To do this, accumulation models can be constructed that link exposure to uptake, compartmentalization and excretion. These models are powerful tools to analyze the separate events and predict the combined result of the processes in a space- and time- resolved manner. Important model input, usually determined from laboratory experiments under well-defined conditions, includes information concerning the concentrations and speciation of the metal present in the exposure media (e.g., water, sediment, food), and data on the kinetics of uptake and elimination of the metal by the organism. This requirement includes information on the feeding rates of the animals under consideration and assimilation efficiencies of the metals from food in the animals. However, once this information is obtained, a model can be used to predict uptake and accumulation under conditions and scenarios that deviate from the experimentally studied cases.

When model predictions for metal accumulation in aquatic animals have been made on a site-specific basis, they have generally matched independent field measurements for metal concentrations in those animals, as shown for marine (Wang *et al.*, 1996a; Griscom *et al.*, 2002) and freshwater bivalves (Roditi *et al.*, 2000), marine copepods (Fisher *et al.*, 2000), and fish (Baines *et al.*, 2002). The close match between model-predicted and measured metal concentration in animals suggests that (1) the laboratory-derived measurements of metal uptake/release parameters are applicable to natural waters, and (2) we can now quantitatively account for the dominant processes governing metal concentrations in marine organisms. Further, models can be used to determine the relative importance of different exposure routes for metal accumulation, the transfer of metals from one trophic level to another, and the effect of changes in exposure conditions and time on the accumulation processes (Blust, this volume).

Different types of dynamic models can be constructed, ranging from very simple one-compartment models to highly complex multi-compartment models. One-compartment models consider the organism as a single homogeneous pool with an input (uptake) and an output (elimination). More complex models incorporate more compartments so that metal uptake and internal compartmentalization are described with more detail and realism. However, the more complex a model becomes, the more information is required to parameterize it. This step requires long-term and detailed experiments and in many cases that information is not available or is difficult to obtain experimentally. Therefore it is important to consider the purpose of the models carefully and decide on that basis what degree of sophistication and resolution is required to answer the questions being addressed. In any case, it has to be realized that models are inherently (over)simplifications of the processes being simulated and that a model is only as good as the quality of the data on which the parameterizations are based and on the soundness and completeness of the assumptions underlying the model structure.

Metals can be eliminated from metabolic pathways either by excretion or by immobilization/sequestration in bones, shells, exoskeletons, or internal precipitates (e.g., Rainbow, 2002). Both uptake rates and elimination rates vary widely among metals, organisms, and environmental conditions. Elimination rates may be particularly slow if accumulation is not limited to specific organs (e.g., liver or kidney) but rather evenly distributed in a large tissue volume. Metabolic processes apparently exert a significant influence on the turnover of metals, in particular those that are predominantly stored in soft tissues, such as methylmercury and radiocesium. Relationships between the metabolism of trace substances and basic environmental parameters may thus assist in the search of general biokinetic models. Quantitative predictions of physiological and ecological kinetics can be generated from simple scaling models and basic physical data, at least to within an order of magnitude (Meili, this volume).

Recommendations

- Given the potential importance of the free metal ion as a predictor of metal bioavailability in aquatic environments, it would be helpful to compile a critical review of those approaches that

can be used either to measure the free metal ion activity or to calculate it. The review could also address the challenge of collecting marine samples without introducing inadvertent contamination.

- Information regarding the role of microorganisms (e.g., protozoa, bacteria, viruses) in the biogeochemical cycling of metals in coastal and pelagic marine systems is deficient. Metal residence times in the water column are inherently sensitive to the size, settling velocity and trophic fate of the particles with which they initially interact – in this context there is a need to quantify the importance of bacteria and viruses in controlling trace metal concentrations and fate in marine systems.
- Since net bioaccumulation of metals reflects the balance between uptake and elimination, the assessment of metal elimination is just as important as that of metal uptake for understanding variability in metal concentrations among biota. Since metal elimination is controlled by internal (physiological) processes, the link between metal turnover (pathways as well as rates) and general biological turnover patterns related to size, activity, growth, and reproduction deserves particular attention (Wang, 2002).
- The partitioning of a metal in a prey organism will influence the trophic transfer of the metal to the consuming organism. For consumers with very simple digestive strategies, the assimilation efficiency of a metal can be predicted from the physical partitioning of the metal in the prey item (i.e., the proportion of the metal that is present in the cytosol). There is a need to extend this knowledge base to include consumers with more intensive digestive strategies, and to take into account the chemical speciation of the metal in the prey.
- The knowledge base for those organisms selected for biomonitoring purposes in the Mediterranean Sea should be completed (e.g., dynamics of metal uptake and elimination, from water and food; influence of organism physiology on metal uptake and elimination; influence of seasonal physiological cycles; influence of changing environmental parameters). This has largely been done for *Mytilus galloprovincialis*, which is virtually identical to *Mytilus edulis*; and, to a lesser extent, for the sea urchin *Paracentrotus lividus* and the seagrass *Posidonia oceanica* (Warnau, this volume). However, similar data bases for other key organisms are not available.
- Modeling rates and routes of metal accumulation in marine organisms can provide a useful framework for understanding key processes and should be incorporated into designing appropriate laboratory and field studies. However, sensitivity analyses should be developed by the modelers to determine how finely measured some of the key uptake parameters (including assimilation efficiencies of metals from ingested food, absorption from the dissolved phase, and efflux rates) need to be so that laboratory experiments can become more efficient and more applicable to field conditions.

3 - ANALYTICAL CHEMISTRY CONSIDERATIONS

In natural aquatic systems, trace metals exist in different chemical forms such as the free hydrated ions, inorganic and organic complexes and metals associated with colloidal particles. The proportion of these different forms may vary continuously with space and time due to concurrently occurring physical, chemical and biological processes. As noted earlier, any variation in the speciation of an element will affect its bioavailability and its overall mobility in the aquatic system. Thus, not only total metal concentration, but also reliable measurements of trace metal speciation in the aquatic environment are essential for studies of trace metal cycling and metal bioavailability. Most of the techniques involved in such measurements (ASV, ligand-exchange/CSV, extraction on C-18 cartridges, etc.) require that analyses be completed on samples brought to the laboratory. The results obtained with these techniques will thus be affected by uncontrolled changes in temperature, pressure, pH, P_{CO_2} and $P_{\text{H}_2\text{S}}$ during sample collection, storage or treatment. Also, many of these techniques require the addition of reagents to the sample that modify the metal speciation. The development of *in situ* analytical techniques to determine the concentration of bioavailable trace substances, in particular free or labile species at high spatial and temporal resolution, could overcome such problems. Since these are often transient products of rapid transformation and equilibration processes, quantification easily leads to manipulation artifacts (i.e., contamination, losses by adsorption, change of speciation due to coagulation of colloids or microbial activity, etc.).

Most of the techniques developed or in the process of being developed for in situ measurements of trace metal speciation in aquatic environment could be divided into two main groups:

- a - Diffusional techniques, which include (i) diffusional equilibration samplers [e.g. dialysis (Hesslein, 1976) and diffusive equilibrium in thin-films – DET (Davison *et al.*, 1991)] and (ii) diffusional preconcentration samplers [diffusion gradients in thin-films - DGT (Davison and Zhang, 1994), and supported liquid membranes - SLM] (Parthasarathy and Buffle, 1994).
- b - Voltammetric techniques, which include the voltammetric *in situ* profiling system (VIP System) using either square wave anodic stripping voltammetry (SWASV) or square wave cathodic sweep voltammetry (SWCSV) – see Tercier *et al.* (1998).

All these techniques and others not mentioned here have certain advantages and limitations. All of them, typically operationally defined to at least some degree, need to be standardized and compared with each other under a wide variety of conditions. Only such well-defined techniques could help in understanding the biogeochemical cycling of trace metals, including transport, bioaccumulation, and toxicity.

Another emerging technology that may be applied as an analytical tool for better understanding metal bioaccumulation and possibly toxicity in marine protists makes use of synchrotron radiation in which target cells are bombarded with hard X-rays. The trace elements in the cells give off characteristic fluorescence patterns when exposed to the X-rays, and software is currently being developed to quantify the amount of metal in individual cells and its site of cellular deposition (Twining *et al.*, in press).

4 - MONITORING IMPLICATIONS FOR UNDERSTANDING BIOACCUMULATION PROCESSES

There was also considerable discussion during the Workshop on biomonitoring programs that consider the accumulation of metals by indicator organisms, usually in coastal waters. Indeed, many monitoring programs are based on bioindicators, using the properties of marine organisms to accumulate contaminants and rendering their measurements technically simpler than in water or sediment. There is also the assumption that levels measured in bioindicators represent an integrated value of the mean ambient load that is biologically available. The objectives of monitoring programs are oriented to provide reliable information on specific issues like human health protection, compliance to regulation standards or risk assessment. In most cases, monitoring programs are not primarily designed to investigate bioaccumulation processes *per se* but to discern spatial and temporal patterns in contaminant concentrations in the environment. However the group tried to identify information gathered from monitoring studies that could be useful in understanding bioaccumulation processes and resulting effects. The group recognizes that there is a need to include both experimentation and observation in any pursuit of understanding bioaccumulation processes. Experimentation controls confounding factors and is the best approach for studying cause-effect relationships, but always simplifies environmental conditions. Observational approaches (including monitoring and field studies) do not control simultaneous variability of many factors (including co-occurrence of a wide range of different contaminants), so cannot ascertain cause-effect relationships. It can be considered that field investigations are the best way to raise questions and draw inferences derived from the complex, natural systems.

Some aspects that have been learned from long-term monitoring programs have been characterized by on-going data interpretations:

1. Variability of pollution inputs (time and spatial scales of effects/exposure conditions).
2. Variability in important aspects of an organism's life cycle that influence bioaccumulation, e.g., condition index, protein synthesis, enzyme activity, reproductive cycle or seasonal growth dynamics in plants, and application of such information in designing/interpreting bioaccumulation experiments.
3. Relationship between bioaccumulation and biological effects along gradients (e.g., enzymatic biomarkers, fertilization capacity, reproductive maturity, immune defenses, population dynamics, etc.).
4. Relationships between inputs to the coastal zone and temporal trends in indicator organisms on a broad scale (e.g., Pb, ¹³⁷Cs, ⁶⁰Co, ¹⁰⁶Ru).

5. Flux measurements in complicated circumstances and inferring significance of proposed phenomena in the field (fecal transport from mussel feces to sediment; metal depletion from the water column).

Monitoring programs provide the following opportunities to learn about bioaccumulation through :

1. Understanding dynamic interactions between natural environmental changes (e.g., season) and bioaccumulation and biomarkers.
2. Observation of responses to cumulative effects or responses to multiple pollutants; spectral and multivariate analyses (e.g., multiple regression or principal component analyses) can help draw inferences from such complex data sets (Sanchiz *et al.*, this volume); analyses of single variable plots can be used to better understand responses that are characteristic of each group of variables.
3. Evaluation of simultaneous responses of batteries of monitoring variables (both in terms of bioaccumulation and biological effects through biomarkers; Odzak, this volume; Moukrim, this volume) in different types of circumstances to identify natural variability (both dynamically stable and stochastic characteristics).
4. Monitoring observations in space (along gradients) and time (after a pulse contamination event) provide excellent opportunities to study/understand bioaccumulation processes, to link bioaccumulation to effects or to test conceptual and quantitative bioaccumulation models (e.g., response to the Chernobyl accident).
5. Monitoring over a long period of time can equate to a controlled experiment, if one variable (e.g., contaminant concentration) changes unidirectionally and characteristics of the natural system do not (e.g., observations over time of a “hot spot” during remediation processes; Hornberger *et al.*, 2000); it then allows inferring effects at any level of biological organization, including those that cannot be realistically (time-scale) investigated in the laboratory (e.g., biological cycles such as reproduction, population and community levels) (Luoma, this volume).
6. Validation of theories developed from laboratory experiments under chronic exposure and complex environmental conditions.
7. Demonstration of differences in bioaccumulation processes and sensitivity to metal contaminants among species; this can lead to understanding which species are most valuable as biomonitors of bioavailable metal concentrations in the environment (i.e., which are most responsive to metal bioavailability), and which species (not necessarily the same) are the best bioindicators of contaminant effects (Luoma, this volume).
8. Test of relationships between proposed measures of bioavailability and actual bioaccumulation responses under complex environmental conditions, including using species difficult to study in the laboratory.
9. Use of conservative tissues to assess long-term trends and/or supplement real time monitoring data (through dating invertebrate skeletons or fish otoliths, lepidochronology in the seagrass *Posidonia oceanica*; Warnau, this volume).

Recommendations

The group suggested a number of recommendations that would improve future research and interpretation of bioaccumulation/monitoring data:

1. There should be a better standardization in the use of monitoring organisms and biomarkers (e.g., homogeneity in sampling and methodologies, quality control of analytical procedures).
2. It was considered that a multi-species approach would be useful to cover a wider range of bioindicative information related to the different compartments of the environment (dissolved phase, suspended particulate matter, sediments); selection of species should take into account their geographical distribution and abundance as well as their ability to accumulate the contaminants of concern (Luoma, this volume; Warnau, this volume).
3. Better advantage should be taken of field studies, in particular along gradients or in “hot spots,” to relate metal concentrations with biomarkers in indicator species used in monitoring studies.

4. Monitoring programs could be designed to improve the interpretative power of the data collected (e.g., addition of relevant ancillary parameters, selection of bioindicators representing well identified trophic levels, etc).
5. Monitoring programs could focus on a battery of valuable biomarkers of exposure and effects and need to develop an algorithm to calculate an integrated stress index (Viarengo, this volume).
6. Monitoring programs should, where possible, be combined with field experiments; such efforts specifically can give better insights into bioaccumulation mechanisms or different problems recognized from the monitoring set of data or laboratory experiments. An example of such experiments is the use of transplanted organisms or *in situ* mesocosms where accumulation is performed under more controlled but still complex environmental conditions (Thébault, this volume).
7. New conceptual models should be developed to consider complex situations, taking into account interactions among different contaminants, including non-metal contaminants in bioaccumulation processes, and subsequent biological effects.

5 - TOXICOLOGICAL CONSIDERATIONS

Research in recent years has shown clear evidence for interactions between trace metal accumulation, homeostatic and detoxification mechanisms, and metal interference with specific metabolic pathways and cell functions.

It is generally accepted that when minimal or physiological amounts of metal cations penetrate into the cells, they are rapidly bound by specific cytosolic ligands such as reduced glutathione (GSH), metallothionein or phytochelatin; metals can also be compartmentalized in lysosomes and granules. Only when the metal uptake rate exceeds the ability of the homeostasis / detoxification systems to process these metals is toxicity evident (Fig. 6). Under such circumstances, these excess metal cations react with cellular components such as enzymes and interfere with metabolic function. The relative importance of specific ligands and detoxification pathways and occur-

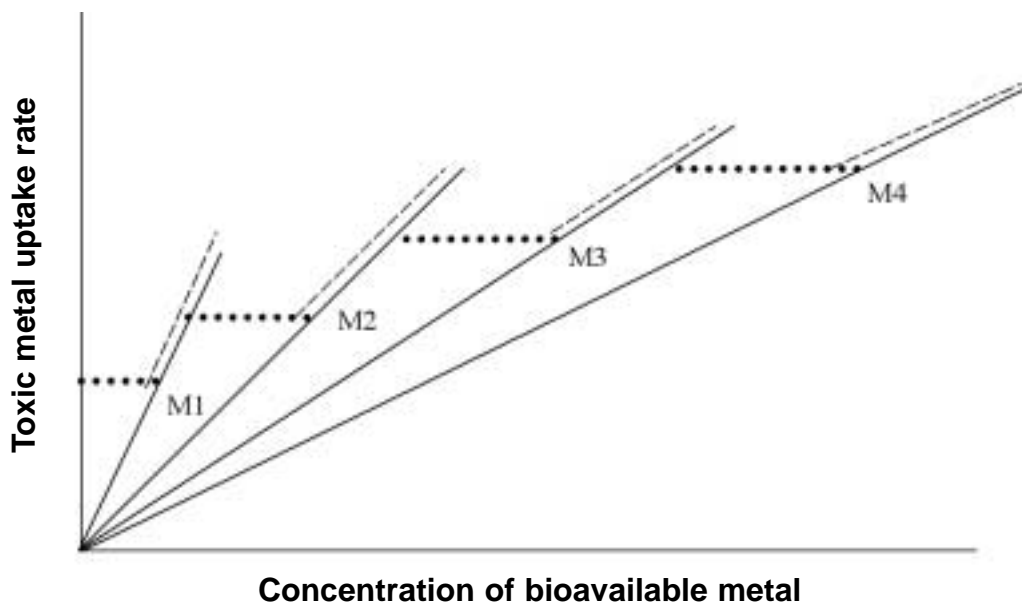

Fig.6. Hypothetical relationship between toxicity of different metals (M1...M4) in an organism as a function of ambient bioavailable metal concentration. The solid lines depict the uptake rates of the metals into the organism, the dotted lines indicate the tolerance limit of the organism for each metal, and the dashed lines indicate toxicity of the metal when the tolerance limits are exceeded for each metal. Note that the tolerance limit is achieved when the rate of metal uptake just equals the maximum detoxification (sequestration plus excretion) rate; when the uptake rate exceeds the detoxification rate, toxicity is exerted. In the figure shown, M1 would be the most toxic metal, M4 the least toxic. The relative toxicities (LC_{50} or EC_{50}) of the metals would be expected to correlate with their affinities for sulfur ligands (Shaw, 1954), with M1 having the strongest affinity and M4 the weakest affinity.

rence of toxicity responses vary in different cells, tissues and species. Further, both intrinsic and extrinsic factors such as changes in the physiological status in relation to season, age, phase of reproductive cycle, etc., all can affect toxic response. Further complicating matters, it is now recognized that synergistic and antagonistic effects can occur with other metals or classes of pollutants. Notwithstanding the complexity of such phenomena, research developed in the past years has elicited some critical aspects of biological effects of pollutants, allowing the characterization of several cellular responses (biomarkers) that can be used to reveal both the exposure and the deleterious effects caused by these contaminants.

As an important pathway of cellular perturbation induced by trace metals, the imbalance between pro-oxidant forces and anti-oxidant defenses leading to enhanced reactive oxygen species (ROS) production and oxidative stress has been pointed out. Different mechanisms and cell interactions can induce similar alterations, including (a) the binding of some metals to sulfhydryl groups of amino acids and proteins, thus altering the redox cellular potential; (b) the impaired functioning of molecules involved in maintaining the redox potential such as the alterations of enzymatic activities related to ROS removal; (c) elements like Fe and Cu also enhance the intracellular generation of oxyradicals acting as catalysts of Fenton-like reactions. Thus, Cu has been shown to induce ROS-mediated damage at the cytoplasmic and at the nuclear level; in the latter case, a clear effect of DNA oxidative damage was demonstrated.

In addition, data are now available showing the effect of trace metals on different aspects of signal transduction pathways, such as the tyrosine kinase cascade, calcium and cAMP, which can explain numerous cellular responses related both to detoxification and appearance of toxic effects at different cellular levels. In this regard, it has been demonstrated that the mechanisms of destabilization of lysosomal membrane, an early event in the activation of lysosomal macromolecular catabolism, is dependent on the free calcium levels and on the activation of Ca-dependent phospholipase A2. This finding may represent the basis for the interpretation of heavy metal effects on the lysosomal vacuolar system, taking into account that it was demonstrated that Hg, Cd and Cu are able to increase free cytosolic calcium concentration in the cells of different marine organisms when present in seawater at nanomolar concentrations.

New tools to better study the biological responses to bioaccumulated metals are emerging in the field of molecular ecotoxicology. Among these, genomics and proteomics play a key role in the evaluation of mRNA and protein profiles that can characterize the functional state of cells and tissues. The possibility to detect variations induced by trace metals on these cellular processes would represent a fundamental step toward the assessment of metal molecular interactions and their involvement in detoxification and toxicity pathways. In this regard, a mini microarray (containing 25 genes related to stress response) has been specifically developed for marine mussels, and will be soon available for both basic research and application in field biomonitoring programs (Viarengo, this volume).

Monitoring programs using so-called sentinel organisms to monitor the marine environment may provide the opportunity to relate metal concentrations to the appearance of potentially deleterious biological effects using biomarkers. A battery of biomarkers (both of stress and exposure) suitable to identify the biological effects attributable to metals is needed. International biomonitoring / research programs, such as MEDPOL and RAMOGE, have found common agreement in the selection of biomarkers to be used for early detection of toxic responses. These core biomarkers should be reviewed in the coming years, taking into account the results of a European-scale project (BEEP, Biological Effects of Environmental Pollutants) that is primarily devoted to this issue.

Recommendations

Given the difficulties in evaluating simultaneous variations of different biomarkers in large biomonitoring programs, it would be appropriate to develop in the near future an algorithm suitable to rank the stress syndrome of monitoring organisms on the basis of changes observed in analyzed biomarkers. It is also recommended that the choice and analysis of biomarkers be standardized among the various biomonitoring programs established for assessing the quality of coastal waters.

6. CLOSING COMMENTS - FURTHER DIRECTIONS FOR RESEARCH

In the course of the workshop discussions, the group noted that important advances have been made in understanding (a) the relationship of metal speciation with bioavailability and passage

across biological membranes, (b) the trophic transfer of metals in marine food webs; (c) the resulting fluxes of metals mediated by organisms in ocean systems; (d) the resulting patterns of toxic responses of organisms to accumulated metals; and (e) the application of biomonitoring programs toward extending the conclusions of laboratory-based studies of metal bioaccumulation toward “real-world” field situations. However, it was felt that more work was needed in areas that have only just begun to receive attention. In addition to the recommended research directions noted above, other priorities include:

1. gaining a better understanding of the mechanisms and rates by which atmospherically delivered metals become bioavailable to marine phytoplankton;
2. examining the interactions of metals with so-called “microbial loop” food webs in general and bacterioplankton and heterotrophic nanoflagellates in particular;
3. evaluating the influence of metal uptake routes on subsequent toxicity in animals; and
4. assessing the effects of multiple metals and/or metals and other contaminants on toxicity in marine organisms.

Predicting metal bioavailability – applicability of the Biotic Ligand Model

Peter G.C. Campbell

INRS-Eau, Terre et Environnement, Université du Québec, Sainte-Foy, Québec, Canada

The Free-Ion Model, or its derivative the Biotic Ligand Model (BLM), is designed to predict how (dissolved) metals interact with, and eventually affect, aquatic organisms. Many of the early insights in this area came from studies with marine and freshwater algae (see Campbell 1995 for a review of these early papers); the purpose of this presentation is to update this earlier review and evaluate how well the BLM approach can explain metal uptake and toxicity in these eucaryotic organisms, and to consider the lessons that algae may teach us with respect to “higher” organisms.

To accumulate within an algal cell and/or to provoke a biological effect, a metal must first interact with a biological membrane. In the bulk solution (Fig. 1, right-hand side), the metal may be present as the free metal ion, or as one or more dissolved metal-ligand complexes. On approaching the surface of the algal cell, these metal forms will normally first encounter the cell wall. The macromolecules making up this highly porous external layer contain a variety of simple functional groups, dominated by O-containing donor groups (-COH; -COOH; -P(O)(OH)²). At circumneutral pH values many of these functional groups will be ionized, affording a hydrophilic matrix of negatively charged sites through which the metal and its complexes must migrate, eventually reaching the plasma membrane (Fig. 1, left-hand side). The important features of this membrane barrier are its overall hydrophobic, phospholipidic character, the presence of proteins – some of which may traverse the lipid bilayer – and the existence of transport proteins and/or ion channels that facilitate the movement of ions across the membrane (Simkiss and Taylor, 1995).

The interaction of a metal with an algal cell will thus normally involve the following steps: (i) diffusion of the metal from the bulk solution to the biological surface; (ii) sorption/surface complexation of the metal at passive binding sites within the protective layer, or at specific binding sites on the outer surface of the plasma membrane; (iii) uptake or “internalization” of the metal (transport across the plasma membrane). The biological “end points” that are normally considered as indicators of “bioavailability” for phytoplankton include metal bioaccumulation (sorption, uptake), as well as metal effects on such processes as photosynthesis, respiration, motility and growth; the goal of the BLM is to predict this bioavailability as a function of the metal’s speciation in the bulk solution.

Within this construct, one normally makes a number of simplifying assumptions (Campbell, 1995; Van Leeuwen, 1999, Di Toro *et al.*, 2001):

1. metal transport in solution, towards the membrane, and the subsequent surface complexation reaction occur rapidly, such that an equilibrium is established between metal

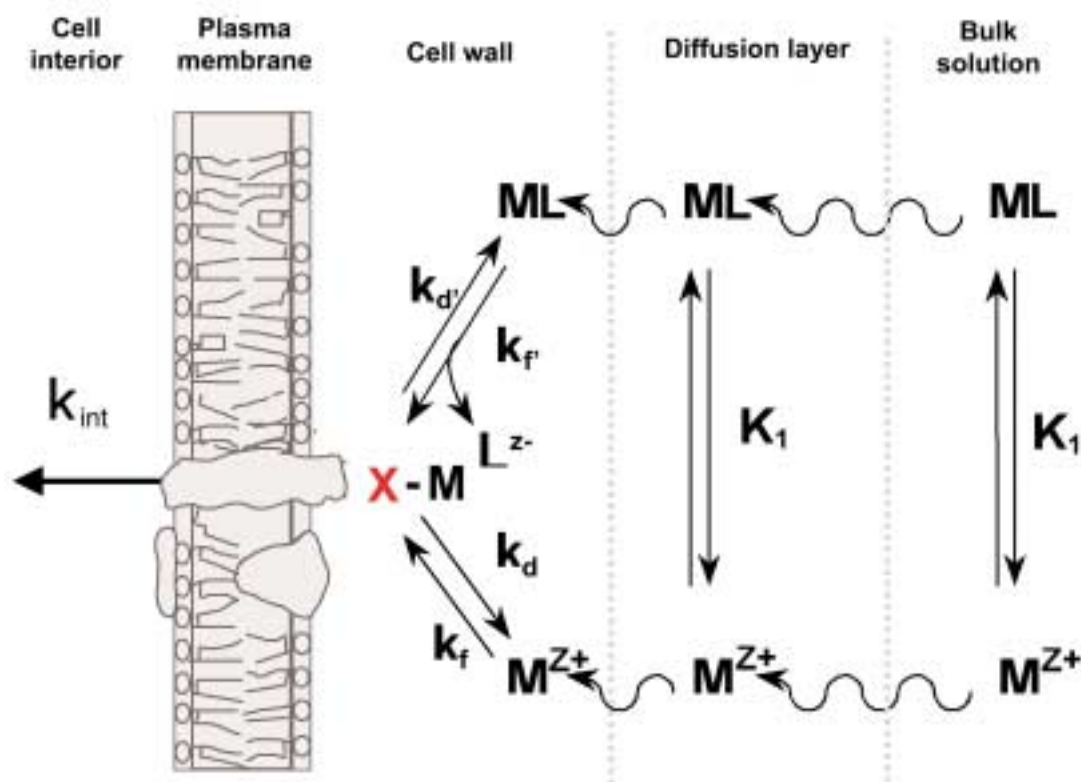

Fig. 1. Conceptual model of metal-organism interactions. M^{Z+} = free-metal ion; ML = metal complex in solution; K_1 = equilibrium constant for the formation of ML ; $M-X$ -membrane = surface metal complex; k_f , k_r = rate constants for formation of the surface complex; k_d , k_d' = rate constants for dissociation of the surface complex; k_{int} = rate constant for "internalization" or transport of the metal across the biological membrane. Charges on ligand not shown for simplicity. [Modified from Campbell (1995)].

species in the bulk solution and those at the biological surface ("rapid" = faster than metal uptake, faster than the expression of the biological response);

2. the plasma membrane is the primary site for metal interactions with living organisms (i.e., the specific binding sites referred to earlier are embedded in the plasma membrane), and this interaction occurs via a ligand exchange reaction, yielding $M-X$ -cell, (Fig. 1, equilibria K_2 or K_3);

3. the biological response, whether it be metal uptake, nutrition or toxicity, is dependent on the concentration of the $M-X$ -cell surface complex, $\{M-X\}$; in those cases where X -cell corresponds to a membrane transport site, metal internalization involves cation transport;

4. variations of $\{M-X\}$ as a function of $[M^{Z+}]$ in solution follow a Langmuir-type adsorption isotherm; provided the concentration of free sites, $\{X\}$, remains relatively constant in the range of metal concentrations of interest, variations in $\{M-X\}$ will follow those of $[M^{Z+}]$ in solution;

5. during exposure to the metal of interest, the nature of the biological surface remains constant (i.e., the metal does not induce any changes in the nature of the plasma membrane or its ion transporters).

Possible mechanistic links between the formation of a surface complex, $M-X$ -cell, and the initiation of a biological effect have been suggested in the literature. If X -cell represents a physiologically active site at the cell surface, then the binding of metal M might induce a direct biological response. Alternatively, if X -cell corresponds to a transport site that allows metal M to traverse the cell membrane and enter the cytosol, then binding at the surface site would simply precede transport into the cell (i.e., the actual reaction of M with the metabolically sensitive site would occur intracellularly, following transport).

If these assumptions are valid, then at constant pH and constant hardness the biological response of the alga should vary as a function of the free-metal ion activity in the exposure solution. Indeed, in the first formal presentation of this conceptual model of metal-organism interactions, Morel (1983) suggested that the “most important result to emerge is the universal importance of the free-metal ion activities in determining the uptake, nutrition and toxicity of all cationic trace metals.” Recent results (some of which will be discussed in the workshop) suggest the need to attenuate this statement, but nevertheless the importance of the free-metal ion activity as a predictor of metal bioavailability remains indisputable.

In the workshop, using freshwater algae as the model organisms, we will re-examine the first three assumptions, namely that metal internalization is slow relative to the other steps involved in metal uptake (Fig. 1), that internalization occurs via cation transport, and that internalization must occur for toxicity to appear. Experimental data will be presented to test each hypothesis. Particular attention will be accorded to apparent “exceptions” to the BLM, since such cases can be taken to define the limits of the model's possible application to the natural environment.

In developing this analysis, we will consider the following topics :

- Laboratory evidence supporting the idea that the biological response elicited by a dissolved metal is usually a function of the free-metal ion concentration, $[M^{z+}]$ (Campbell, 1995).
- Documented exceptions to the Biotic Ligand Model (e.g., passive diffusion of neutral lipophilic species; accidental transport of metals as complexes with assimilable ligands; formation of ternary complexes at the cell surface, L-M-X-cell). Recent experiments with algae will be described, demonstrating anomalously high metal toxicity in the presence of common low molecular weight metabolites (citrate and alanine), or in the presence of an assimilable anion (thiosulphate) (Fortin and Campbell, 2001; Campbell *et al.*, 2002).
- Tests of the Biotic Ligand Model in the presence of natural organic matter (fulvic / humic acids). The demonstration that natural organic matter (DOM) tends to accumulate at biological surfaces (Campbell *et al.*, 1997), particularly at low pH values, raises a number of intriguing questions about the ambient chemical environment close to the cell surface – the consequences of this accumulation on metal-cell interactions will be discussed (Vigneault *et al.*, 2000).

The following preliminary conclusions are offered for discussion :

- The first hypothesis, that metal uptake is under thermodynamic control (i.e., that internalization is slow relative to the transport of the metal from the bulk solution to the algal surface and its reaction at the algal surface), is rarely tested. Comparisons of calculated metal diffusion rates in the phycosphere with measured metal uptake rates, on a common (membrane) areal basis, suggest that under certain conditions the diffusive supply of the metal from the bulk solution may prove to be the rate-limiting step (Fortin and Campbell, 2000; Pinheiro and Van Leeuwen, 2001). Under such conditions, all labile diffusive species will contribute to metal uptake, and metal uptake will prove insensitive to changes in the distribution of the metal among the different labile forms. These questions of metal supply from the ambient water may also be important for higher organisms, where metal uptake across respiratory epithelia could in theory be limited by the advective and/or diffusive supply of metal to the gill surface.
- The second hypothesis, that metals can only enter algal cells via cation transport pathways, is clearly wrong (Fig. 2). There is now evidence for the piggyback uptake of Ag as the Ag-thiosulfate complex (Fortin and Campbell, 2001), and Cd as the Cd-citrate complex (Errécalde and Campbell, 2000), via anion transport systems. In addition, there is unequivocal evidence in the literature that neutral lipophilic metal forms can cross algal membranes by passive diffusion (Florence and Stauber, 1986; Phinney and Bruland, 1994). Low molecular weight metabolites are also naturally present in animal digestive tracts, as breakdown products of the digestion process. Since the epithelial membrane in the gut is naturally rich in transport systems designed to assimilate these molecules, it seems logical that the piggyback metal uptake observed with algae in the present experiments may well occur in the gut.

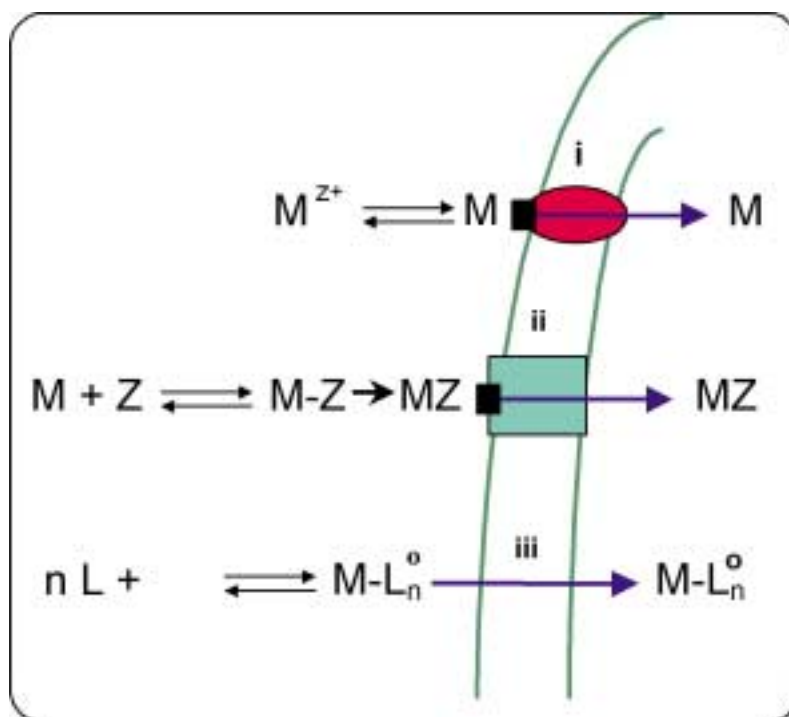

Fig. 2. Mechanisms by which metals can enter living cells: (i) facilitated transport of metal cations; (ii) accidental or piggyback transport of a metal complexed with an assimilable ligand; (iii) passive diffusion of a lipophilic metal-ligand complex.

- With respect to the final hypothesis examined, that metal interactions at the biological surface lead to the formation of a simple $M-X$ -cell complex, and that metals must be internalized before they can exert their toxic action, there is evidence suggesting that metals can in fact exert their toxic action by binding to sites present at the membrane surface (i.e., that membrane transport is not a necessary condition for metal-induced toxic effects to occur), and that under such conditions both $\{M-X\text{-cell}\}$ and the ternary complex $\{L-M-X\text{-cell}\}$ can contribute to metal toxicity. In such cases, the concentration of the surface species $\{M-X\text{-cell}\}$ and $\{L-M-X\text{-cell}\}$, and the biological response, will be influenced by variations of both $[M^{Z+}]$ and $[ML]$ in the exposure solution; if the response is additive, then the metal will appear to be more bioavailable than predicted on the basis of the BLM.

Possible topics for additional group discussion might include: determinations of free-metal ion concentrations in systems containing natural dissolved organic matter, the identification of lipophilic ML_n^o species in natural waters, and the elucidation of metal speciation at biological interfaces and within organisms (cytosolic metals).

Acknowledgements. Funding for our research on metal-organism interactions has been provided by the Natural Sciences and Engineering Research Council of Canada, Kodak Canada, the Quebec Fonds de formation de chercheurs et l'aide à la recherche, and the Canadian Network of Toxicology Centres / Environment Canada. Particular thanks are extended to several former graduate students (Claude Fortin, Robert Roy, Michael Twiss, Bernard Vigneault and Kevin Wilkinson), who contributed to the development of many of the ideas presented in this abstract.

Physiology, physicochemistry and the uptake of dissolved trace metals by crustaceans

Phil Rainbow

The Natural History Museum, London

Trace metals are taken up by aquatic invertebrates from solution across the cell membrane of permeable surfaces by one or more transport routes (Simkiss and Taylor, 1995), such as :

- a) carrier-mediated transport whereby a metal ion binds with a membrane protein,
- b) a membrane channel consisting of a protein with a hydrophilic core through which metal ions are transported, perhaps to be considered as a variant of the carrier protein route (Simkiss, 1996);
- c) passive diffusion of lipid-soluble (non-polar) metal forms which dissolve in the lipid bilayer, including alkyl-metal compounds and neutral, non-polar inorganically complexed metal species (eg HgCl_2^0);
- d) endocytosis when a region of the cell membrane invaginates to engulf a metaliferous particle for transfer into an intracellular vesicle.

It is generally considered that it is the free metal ion that is available for transport across the cell membrane via a carrier protein or through a membrane channel, and therefore that the free metal ion concentration (strictly activity) is the best predictor of the bioavailability of dissolved metal (Campbell, 1995). Once trace metals are across the cell membrane, their binding with non-diffusible cytosolic proteins of higher affinity for the metal ensures that they continue to enter passively, even though the internal concentration of total metal in the cell is higher than the external dissolved metal concentration. In seawater, dissolved zinc and cadmium, like many other trace metal ions, are partitioned in equilibria between (predominantly) inorganic and organic complexing agents. Thus zinc is complexed by chloride and hydroxide with about 47% present as the free hydrated Zn^{2+} ion, and cadmium by chloride with 2.5% as the free Cd^{2+} ion (Bruland, 1983; Rainbow *et al.*, 1993).

While the concentration gradient for trace metal entry is maintained passively by their high affinity binding intracellularly, concentration gradients for other metal ions may require the use of energy, eg. in membrane-bound ATPases. Major ions like Na^+ and K^+ do not have such high affinities for complexing agents including proteins, and remain uncomplexed as hydrated free metal ions in seawater (Bruland, 1983). Thus $\text{Na}^+\text{K}^+\text{ATPase}$ in the basal cell membrane of the ionocyte cells of the gills of decapod crustaceans maintains a low intracellular Na^+ concentration, allowing sodium to enter apically down a concentration gradient via sodium channels. Similarly an ionic concentration gradient promoting Ca^{2+} uptake via apical Ca channels is maintained by the active pumping out of Ca^{2+} ions, basally in the same gill ionocytes of decapods (Rainbow, 1997b).

The uptake of the dissolved metal ion will take place by more than one route. Thus uptake of zinc might take place via the diffusion of ZnCl_2^0 through the lipid bilayer as well as via the binding of the free Zn^{2+} ion to a membrane protein, but there may be an enormous difference between rates of entry by different routes. Similarly it is inevitable that trace metal ions will enter via channels for major ions if they are of the same size, but again the relative importance of this route will vary, not least with the activity of the major ion pumps. For example the cadmium ion Cd^{2+} has an ionic radius of 0.92 Å while that of Ca^{2+} is 0.94 Å, ensuring some entry of Cd by Ca channels.

In the case of crustaceans, free zinc and cadmium ions do appear to play central roles in the uptake of dissolved metal (Rainbow, 1995, 1997b). The free metal ion concentration will alter with changes in total metal concentration, changing the rate of metal uptake. The free metal ion concentration can, however, also be altered without changing the total dissolved metal concentration, by altering the availability of water-soluble metal binding ligands. Thus EDTA reduces the absolute equilibrium concentration of the free Zn^{2+} ion, and reduces the rate of zinc uptake by the amphipod *Orchestia gammarellus* and the decapod *Palaemon elegans*, in the latter case in direct correlation with the predicted free zinc ion concentration (Rainbow, 1995, 1997). Changes in salinity will also alter the concentration of inorganic complexing agents, particularly chloride. Thus the concentration of free zinc ions will increase as salinity decreases. If the rate of uptake is, therefore, determined by the free zinc ion concentration, decreases in salinity should produce predictable increases in zinc uptake rate. This is indeed the case for the decapod crustaceans *Palaemon elegans* and *Palaemonetes varians*, and for the amphipod *O. gammarellus* at salinities down to 25 (Rainbow, 1997b).

Changes in salinity may also have an effect on the physiology of an aquatic invertebrate. An estuarine decapod crustacean exposed to reduced salinity will have body fluids hypertonic to the medium, promoting the osmotic uptake of water. A decapod typically responds to the increased osmotic uptake of water by increasing urine production; the urine is isotonic to the blood and its increased production results in the loss of major ions as well as the increased expulsion of water. The loss of major ion is balanced by active uptake of major ions in the gill ionocytes. Thus a decrease in salinity will be associated with a physiological response increasing the active uptake of major ions. If a trace metal enters via the route for uptake of a major ion, then decreased salinity will cause increased trace metal ion uptake by this route, irrespective of any physicochemical change promoting release of the trace metal ion from inorganic complexation.

One way to distinguish between the physicochemical effect of decreased salinity promoting free metal ion activity and a physiological response by the decapod to low salinity is to vary salinity (concentration of inorganic ions) and osmolality (total dissolved solutes) independently. In seawater, inorganic ions, dominated by sodium and chloride ions, in effect control osmolality and changes in salinity and osmolality occur concurrently. It is possible, however, to separate changes in osmolality from those in salinity by adding an organic molecule, eg. sugar D-fructose, which does not chelate zinc. Work on *Palaemon elegans* increased the osmolality of 25% seawater to that of 75% seawater, without increasing the concentration of inorganic ions. This adjusted medium would show the zinc complexation characteristics (and free zinc ion concentration) of 25% seawater, but stimulate energy-dependent major ion uptake by the decapod to the same extent as 75% seawater. The zinc uptake rate of *P. elegans* matched that in 25% seawater, not 75% seawater, and so zinc uptake does not appear to involve active uptake routes for major ions.

A physiological parameter that differs between crustaceans with the potential to affect trace metal uptake rates is the Apparent Water Permeability, AWP (Rainbow, 1997b) which decreases in crustaceans along the habitat salinity gradient from marine to freshwater, as do crustacean metal uptake rates (Rainbow, 1997b). Some crustaceans (eg. the crab *Carcinus maenas*) have the ability to alter AWP as a physiological response to salinity change (Rainbow and Black, 2001) and this response may correspondingly affect trace metal uptake rates.

Chan *et al.* (1992) compared the zinc and cadmium uptake rates of two populations of *Carcinus maenas* – one from Scotland at high salinity (33), and the other from the southern Kattegat, Denmark (15-20). Zinc uptake rates did not show the increases with decreased salinity

expected from the physicochemically determined increases in free zinc ion concentrations. The Scottish crabs actually showed a decrease in zinc uptake rate with a salinity decrease from 35 to 15, while the Danish crabs showed no change in zinc uptake rates between 33 and 15; in all cases the Danish crabs had the lower zinc uptake rates (Chan *et al.*, 1992). The authors proposed that the results may be explained in terms of changes in AWP, the physiological response to low salinity counteracting the physicochemically driven increases in free zinc ion availability. Results for cadmium uptake were consistent with this interpretation.

To investigate further the interaction of physicochemical effects of low salinity on the uptake of zinc by crustaceans, and any physiological response to low salinity, we chose three crabs from habitats of different salinity exposure:

- a) *Carcinus maenas*, a littoral and sublittoral euryhaline species, known to make physiological responses to salinity changes which can offset changes in zinc speciation.
- b) *Eriocheir sinensis*, an extremely euryhaline crab which spends its adult life in fresh-water.
- c) *Necora puber*, a presumed more stenohaline marine species, lower shore and sublittorally.

Reduced salinities caused increases in the zinc uptake rate of *E. sinensis* as expected from the free metal ion model, with increased free zinc ion availabilities with reduced chloride complexation. For *C. maenas* and *N. puber*, however, reduced salinity was associated with reduced zinc uptake, interpreted in terms of a physiological response by these crabs to low salinity offsetting the physicochemical effect of increased free zinc ion availability. Results can be partly explained by changes in apparent water permeability (AWP), although experiments manipulating solution osmotic pressures independently of salinity indicate that other physiological responses may also be coming into effect.

The interaction of physiology and physicochemistry in controlling trace metal uptake from solution clearly varies between species.

Metal bioavailability and bioaccumulation in the marine environment : methodological questions

Michael O. Angelidis¹ and Vassiliki-Angelique Catsiki²

¹ Department of Environmental Studies, University of the Aegean, Mytilene, Greece

² National Centre for Marine Research, Hellinikon, Athens, Greece

INTRODUCTION

The potential threat of metals to aquatic organisms has been directly and indirectly assessed during recent decades, using several methods. As an indirect measure of the abundance and availability of metals in the marine environment the bioaccumulation of metals by the tissues of marine organisms has been studied. The bioaccumulation studies led to the adoption of the bio-indicator concept (Langston and Spence, 1995). Bivalves and fish are widely used as bio-indicators of marine pollution by metals (Evans *et al.*, 1993). According to the mechanisms of absorption, regulation, storage and excretion of trace metals, the various tissues used for analyses present varying bioaccumulation rates and due to their different roles in the above processes, their analysis may lead to different interpretations.

Metal bioavailability can be also assessed using abiotic samples, such as water and sediment. Metal speciation in these media is often used to evaluate the metal bioavailability although the methods vary. Metal bioavailability in water is related to the actual “mobility” of the metal chemical species (labile metals) while in sediments extraction methods are applied in order to remove (and analyze) the more (presumably) bio-active part of the metal (adsorbed, oxidisable, etc). Therefore there is a basic difference in the speciation approach between the two media : in the water we are searching for the most actually active metal part, while in the sediments we are targeting the most potentially active part of the metal. However, because the sediment undergoes diagenetic changes mainly because of its organic content, the potential threat of the sediment-bound metal is considerable.

METAL SPECIATION IN SEDIMENTS

Sediments are the solid phase in the aquatic environment that controls the dissolved level of metals by mechanisms of sorption-desorption and dissolution-precipitation. In order to assess the environmental impact of a given pollutant the following points must be addressed in contaminated sediment-water systems (Kestern and Forstner, 1995) :

- What is the reactivity of the metals introduced with solid materials from anthropogenic activities by comparison with the natural component ?
- Are the interactions of critical metals between solution and solid phases comparable for natural and contaminated systems ?



Fig. 1. Location of fish sampling areas in Aegean and Ionian seas.

- When do the solid inputs or the solid-solution interactions lead to weaker bonding of certain metal species?
- Are the factors and processes of remobilization effective in contaminated as compared with natural systems?

Sequential extraction is a method that can operationally define different major carriers of metals in marine sediments, as has been shown in many cases around the world. However, experience shows that serious care has to be given to avoid artifacts during sampling, storage, pretreatment and analysis, which will lead to erroneous results. The practicability of the technique for metal partitioning in anoxic sediments is questionable and in all cases serious consideration of the possible artifacts has to precede the use of the method. The method does not provide information on the actual species of the metals in sediment but can be used as long as it is understood that the fractions obtained are dependent on the reagent used (Angelidis, 2000). For practical use of the sequential extraction methodology, a certified reference material (sediment) has been produced and a standardized sequential extraction scheme has been proposed by CEC/BCR (Ure *et al.*, 1993). Alternatively, a simple extraction with a mild agent (acetic acid, diluted HCl) can provide enough information on the less thermodynamically stable fraction of metals in the sediments, which is also the most easily available for uptake by marine organisms.

Pore water is the most sensitive indicator for describing the type and extension of the diagenetic processes, which is controlling the metal partitioning between solid and dissolved phase and therefore their potential bioavailability. Partition coefficients, K_d s, have been used as a methodological tool to study the metal mobility within the sediment column (Lee *et al.*, 1997; Warnken *et al.*, 2001). Partition coefficients (K_d s), especially their logarithms ($\log K_d$), are a convenient

parameter to quantify and rank the relative strength of the association of individual contaminants mainly trace metals with suspended particulate matter and sediment in natural waters. K_d s are defined by the relationship $K_d = P/D$ where P and D denote total metal concentration in the solid and aqueous phases respectively (Olsen *et al.*, 1982). Lee *et al.* (1997) suggested the term "apparent distribution coefficient" due to a possible colloidal fraction merged with dissolved species.

Partition coefficients (K_d s) of Fe and Mn were used as indicators of metal mobility in the sediment and water column in the marine coastal environment of the island of Lesbos, Aegean Sea and were able to describe metal mobility caused by the reducing conditions prevailing in the upper sediment layers. The logarithms of partition coefficients ($\log K_d$) of Mn in sediment columns of Kalloni Bay ranged from 2.12 to 5.84 (mean 4.25), while Fe $\log K_d$ s ranged from 3.95 to 7.01 (mean 5.39). These values are 1 to 1.5 units lower than the corresponding values in the overlying water column. However, the differences between K_d s in sediment and water of Kalloni Bay were less important compared to more reducing marine environments, where they can reach 2.5 units (Warnken *et al.*, 2001; Wen *et al.*, 1999). In those extremely reducing environments $\log K_d$ of Mn in sediments can reach values close to 2. For Fe, which is less sensible in redox changes and therefore less mobile, its K_d in the water column was much higher than Mn in all environments as expected (Table 1) (Gavriil and Angelidis, 2002).

Table 1. Mn and Fe partition coefficients ($\log K_d$ s) in some aquatic systems.

| Area | Fe | Mn | Reference |
|---------------------------------------|---------|---------|------------------------------|
| Kalloni bay (Sediment column) | 5.4±0.4 | 4.2±0.4 | Gavriil and Angelidis, 2002 |
| Kalloni bay (Water column) | 6.8±0,6 | 5.7±0,3 | " |
| Galveston Bay (USA) (Sediment column) | 4.3±0,5 | 2.0±0,3 | Warnken <i>et al.</i> , 2001 |
| Galveston Bay (USA) (Water column) | 6.9±0,5 | | Wen <i>et al.</i> , 1999 |

BIOINDICATORS

Fish and mollusks have been widely used for monitoring metal bioaccumulation in the aquatic environment. In the Greek seas (Aegean and Ionian) extensive monitoring was done in the frame of the MEDPOL program, realised under UNEP guidelines, and the effectiveness of several aquatic organisms as biomonitors for temporal evolution studies was investigated. (Catsiki and Stroglyoudi, 1999; Catsiki *et al.*, 2001) (Fig. 1). Data sets covered a period of ten years of sampling (1987-1997). The metals Cu, Cr, Ni, Zn, Fe and Mn were determined in the gills and flesh of the demersal *Mullus barbatus* (striped mullet) and the pelagic fish *Boops boops* (bogue), and in the flesh of the mussel *Mytilus galloprovincialis*, and of the mollusk *Patella* sp.

In the demersal fish *Mullus barbatus*, a statistically significant correlation (linear regression) was found between the concentrations of metals in the gills and the flesh (Fig. 2), although the metals levels in gills were higher than in flesh. These results indicated that the metal contents in different fish tissues presented similar fluctuation patterns, although the metal accumulation mechanisms are different (flesh is related to metabolised metals, via food, while gills are the primary site of metal uptake from the water – Romeo *et al.*, 1994). Metals in the flesh of fish presented lower variability than in the gills or the mussels because fish flesh constitutes a more long term indicator, which is related to metal metabolism and not to incidental short changes in the marine abiotic environment. The temporal evolution of metal bioaccumulation by fish during the 10-years study exhibited numerous fluctuations due to environmental, meteorological and biological factors. However, after using a locally weighted regression smoothing technique (Catsiki and Stroglyoudi, 1999), it was found that Cu, Ni and Zn seem to increase with time at all the sampling sites, while Cr and Fe seem to decrease.

In all cases the metal concentrations in the different tissues of the organism could be statistically related to "contamination". That means that organisms from areas considered as polluted (because of known pollution sources and /or enhanced metal concentrations in abiotic environmental samples) presented significantly higher metal concentrations than organisms from non-polluted areas.

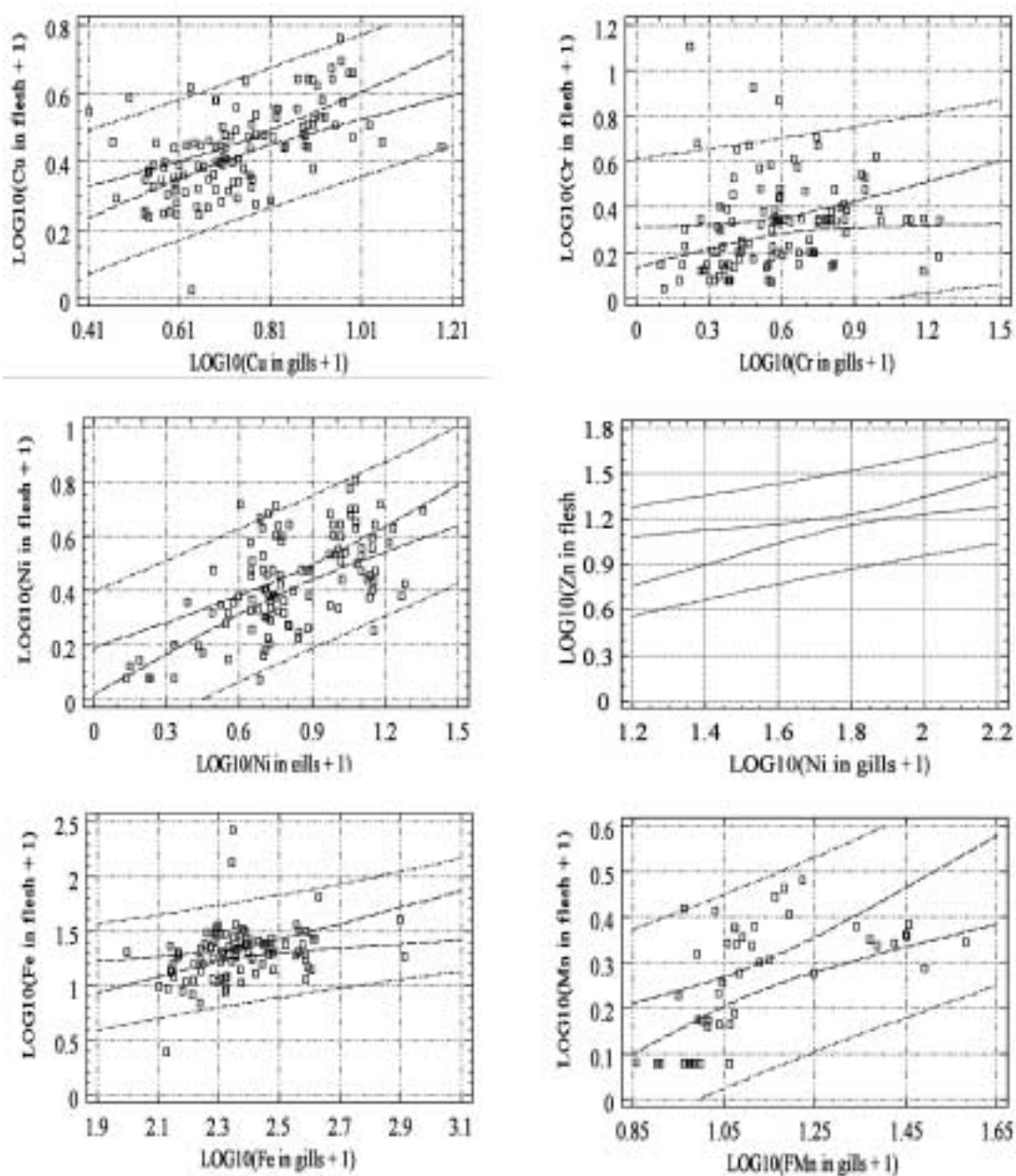

Fig. 2. Regression analysis of the concentration of a metal in gills vs. its concentration in flesh of the same individual (results based on the data of demersal fish collected at station 6).

CONCLUSION

It is certain that metal concentrations in bioindicators as well as metal speciation in abiotic samples have to be monitored in order to detect the trends in metal levels in the aquatic environment. Partitioning between solid and dissolved phase in the sediment column is a very important factor for the transfer of metals to the biota and has to be more extensively monitored. This is particularly true when studying coastal sediments, which contain important metal deposits (estuaries, river mouths, and coastal development – urban, industrial).

The metal content in the tissues of marine organisms can be successfully used to monitor metal pollution, as was found in specific locations with known pollution sources. However, in the Greek Seas the temporal trends, which were detected in metal concentration in fish tissues, were attributed to meteorological changes in the areas since there was no evidence to support an anthropogenic impact.

Trace metal bioavailability in saline waters Field experiments

Niksa Odzak

*Institute of Oceanography and Fisheries (IOR), Split, Croatia - Swiss Federal Institute for
Environmental Science and Technology (EAWAG), Duebendorf, Switzerland*

INTRODUCTION

Primary concern to water quality is how readily toxicants such as trace metals are taken up by biota. Bioavailability, which refers to the fraction of the total quantity of a metal in the environment that is potentially available for biological effects, is affected by numerous physico-chemical (e.g. temperature, salinity, dissolved O₂, pH) and biotic factors (e.g. age, size, reproductive cycle). It depends on the molecular structure of the metal species, their thermodynamic stability and the chemical kinetics of their interaction in a biological membrane.

Trace metals may be taken up by aquatic organisms mainly from solution and from food. Mussels, as filter feeders, effectively filter particulate matter out of a suspension (Cossa, 1989). Suspended matter, therefore, may be a source of trace metals if ingested by mussels. The extent to which ingested particulate matter can be the source of trace metals depends not only on the trace metal concentration in suspended matter, but also on the quantity of ingested suspended matter and the absorption efficiency of ingested trace metals. Among the chemical characteristics of suspended particles that might influence bioavailability of trace metals, the organic content have been shown to have a pronounced effect (Gagnon and Fisher, 1997).

MATERIALS AND METHODS

Three age groups of marine mussel *Mytilus galloprovincialis* were transferred from the clean area (Mali Ston Bay, Middle Adriatic coast, Croatia) to the experimental station in a relatively polluted area (Kastela Bay, Croatia) (Fig.1). Laboratory experiments, had suggested that younger mussels accumulate trace metals from the water faster than older ones (Odzak *et al.*, 1994). That is why, to study bioaccumulation kinetics, we have chosen three different age groups.

According to the most recent results of biomonitoring conducted in the bay during the last three years, the season has a large influence onto metal bioaccumulation into the mussels (Odzak *et al.*, 2000; Odzak *et al.*, 2001). For that reason, the experiments were conducted in summer (21 June-27 July 2001) and in winter (23 January-07 March 2002). During each of those two experimental periods the mussels, suspended matter (sediment traps) and biofouling organisms (plexiglas plates) were sampled six times (Fig. 2). Biofouling organisms (benthic algae) were not transplanted to the experimental station. They were growing for two months at the site on a plexiglas plates before the experiment started. The same trace metals as in the mussels (Hg, Cd, Pb)

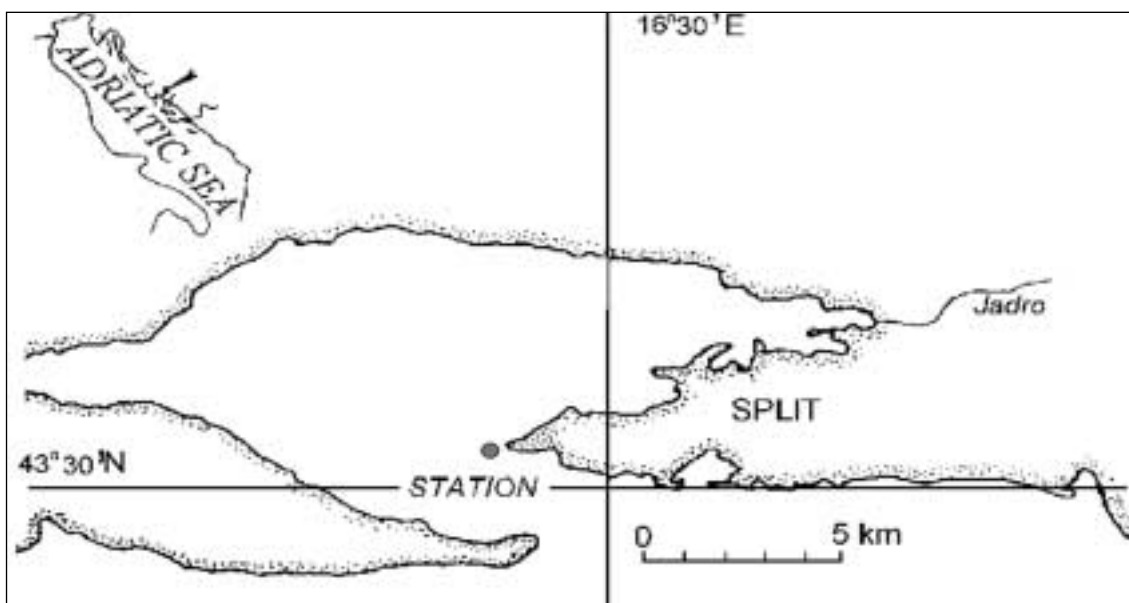

Fig. 1. The study area with experimental station.

were measured in biofouling organisms and in particulate matter deposited in the sediment traps. Diffusive gradients in thin-films (DGT) was used to measure trace metal concentrations in the saline water. This technique provides an in situ means of quantitatively measuring labile metal species in aqueous systems and could help in better understanding of trace metal bioavailability to the marine organisms.

At the same station, temperature, pH, O₂, salinity and sea level were measured. Also, meteorological situation (wind direction and velocity, rain quantity and air pressure) was monitored.

RESULTS AND DISCUSSION

Mercury

Organic matter concentration showed a very good positive correlation with the Hg concentration in suspended matter throughout summer and winter experimental period. Obviously, Hg was mainly bound to the organic part of suspended matter. Relatively good correlation existed among sedimentation rate, Hg concentration and Hg quantity in suspended matter. In winter

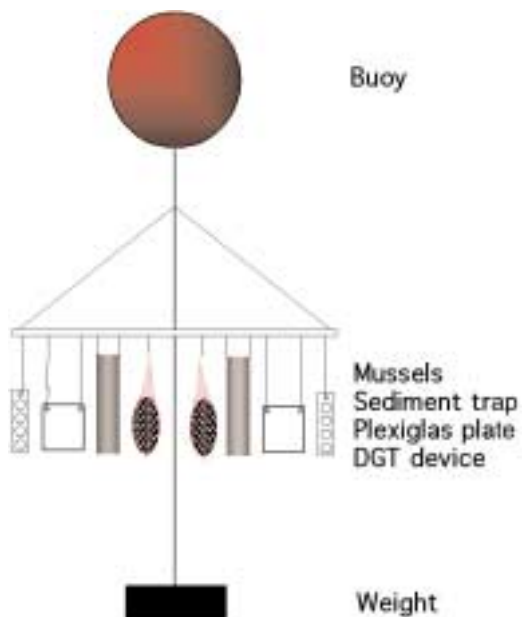

Fig. 2. Experimental set up.

experimental period the average sedimentation rate, average Hg concentration and total Hg content in suspended matter were higher than in summer (Table 1). At the same time, average dissolved Hg concentration was lower in winter.

Compared to the summer experiment, average Hg concentrations were higher in the older mussels (B and C age group) and slightly lower in the youngest age group. The average Hg concentrations in biofouling organisms were lower during winter experiment (Table 2). In summer, the concentrations in mussels were increasing from the beginning of the experiment and it seems that age groups A and B achieved some kind of dynamic equilibrium after three weeks (Table 3). The oldest mussels achieved the equilibrium one week later. Contrary to the summer experiment, in winter the oldest mussels achieved some kind of dynamic equilibrium in a second week.

Conclusions: Hg

- Hg in suspended matter is mostly bound to organic matter
- Food is the main source of Hg for mussels
- Water is the main source of Hg for biofouling organisms
- Mussels accumulate more Hg (and faster) in winter
- In winter bioavailability of Hg is better for mussels, but not for biofouling organisms

Table 1. Average metal concentrations in the water and in suspended matter

| METAL | SEASON | DISS.METAL | SUSPENDED MATTER | | | |
|-------|--------|------------|-------------------------|-------------|----------------|-------------|
| | | | Sed.rate | Metal conc. | Metal quantity | Org. matter |
| Hg | Summer | 2.4 ng/L* | 4.5 g/m ² /d | 474 ng/g | 2.1 µg | 12.9 % |
| | Winter | 1.9 ng/L* | 5.5 g/m ² /d | 595 ng/g | 2.8 µg | 14.1 % |
| Cd | Summer | 19 ng /L | | 0.22 µg/g | 0.97 µg | |
| | Winter | 16 ng/L | | 0.19 mg/g | 1.07 µg | |
| Pb | Summer | 0.09 mg/L | | 124 µg/g | 552 µg | |
| | Winter | 0.06 mg/L | | 74 µg/g | 395 µg | |

* Not measured in-situ (measured in the laboratory using FIMS AAS)

Table 2. Average metal concentrations in the mussels and biofouling organisms

| METAL | SEASON | MUSSELS | | | BIOFOULING |
|-------|--------|-------------|-------------|-------------|------------|
| | | Age group:A | Age group:B | Age group:C | |
| Hg | Summer | 138 ng/g | 111 ng/g | 111 ng/g | 240 ng/g |
| | Winter | 133 ng/g | 159 ng/g | 162 ng/g | 158 ng/g |
| Cd | Summer | 0.52 µg/g | 0.46 µg/g | 0.53 µg/g | 0.21 µg/g |
| | Winter | 0.60 µg/g | 0.63 mg/g | 0.91 µg/g | 0.13 µg/g |
| Pb | Summer | 1.2 µg/g | 0.82 µg/g | 0.89 µg/g | 25.4 µg/g |
| | Winter | 1.0 µg/g | 1.0 µg/g | 1.12 µg/g | 14.8 µg/g |

Table 3. Metal concentrations accumulated in mussels from the beginning of the experiment until establishment of dynamic equilibrium

| METAL | SEASON | MUSSELS | | |
|-------|--------|----------------------|----------------------|----------------------|
| | | Age group:A | Age group:B | Age group:C |
| Hg | Summer | 34 ng/g (3th week) | 23 ng/g (3th week) | 33 ng/g (4th week) |
| | Winter | 0 | 27 ng/g (3th week) | 63 ng/g (2nd week) |
| Cd | Summer | 0 | 0 | 0.18 µg/g (3th week) |
| | Winter | 0 | 0.01 µg/g (2nd week) | 0.20 µg/g (2nd week) |
| Pb | Summer | 0.37 µg/g (3th week) | 0.45 µg/g (3th week) | 0.33 µg/g (4th week) |
| | Winter | 0 | 0.30 µg/g (2nd week) | 0.51 µg/g (2nd week) |

Cadmium

Total Cd quantity in suspended matter was highly dependent on the sedimentation rate. Very good positive correlation existed between those two parameters. Average Cd concentrations and Cd quantities in suspended matter in winter were similar or slightly higher than in summer (Table 1). During summer experimental period we had two characteristic situations concerning Cd concentrations in suspended matter. The first one was in the second week of the experiment (from 27 June-3 July) during relatively strong NE wind, when we had a slightly higher sedimentation rate and a slightly higher Cd concentration in the suspended matter. This resulted in a higher total Cd quantity in suspended matter. The second characteristic period was during the rain event and at the same time relatively strong SE wind (from 15-21 July). This time the sedimentation rate was high, but Cd concentration in suspended matter was slightly decreasing, causing total Cd quantity increase but not so much like during the first event (27 June-3 July). Organic matter concentration was increasing during the first event, similar to the increase of sedimentation rate, Cd concentration and Cd quantity in suspended matter. During the second event (15-21 July) organic matter concentration was decreasing although sedimentation rate was increasing. This leads to the conclusion that at that time increase of the sedimentation rate was caused mainly by the inflow of inorganic particles, which were not so rich in Cd.

Dissolved Cd concentration was measured *in situ* using DGT (diffusive gradients in thin films). It measures labile trace metal forms and has been postulated as possible alternative to bivalves as a mean of assessing metal pollution (Davison and Chang, 1994). In our experiment, Cd concentration measured by DGT was in a good correlation with total Cd quantity in the suspended matter. Dissolved Cd concentration in summer was slightly higher than in winter (Table 1).

Average Cd concentrations were higher in winter than in summer in mussels, but lower in biofouling organisms (Table 2). Cd concentration in mussels was significantly increasing from the beginning of the experiment only in the oldest age group. Cd concentration in these mussels (age group C) was increasing very fast and only after three weeks in summer and two weeks in winter they achieved some kind of dynamic equilibrium with the environmental concentrations (Table 3). Again, the trend showed that older mussels react slightly slower to the increased environmental Cd concentrations. Further, the results showed that in the situation when environmental Cd concentration does not differ significantly from the concentration at the place of origin, the depuration rate is similar to the accumulation rate.

Very good correlation existed between Cd concentrations in biofouling organisms and labile Cd concentrations measured *in situ* by DGT. Obviously, for these organisms the main source of Cd is the water.

Conclusions: Cd

- Food is the main source of Cd for mussels
- Water is the main source of Cd for biofouling organisms
- Mussels accumulate more Cd (and faster) in winter (better bioavailability)
- Bioavailability of Cd for mussels is better when it is bound to organic matter
- Oldest mussels accumulate higher Cd concentration (few days delay after max. concentration in susp. matter)
- Depuration rate is similar to accumulation rate

Lead

Compared to the summer experimental period, average Pb concentrations and Pb quantities in suspended matter were slightly higher in winter (Table 1). At the same experimental period, dissolved Pb concentrations (measured *in situ* by DGT) were slightly lower than in summer.

The average Pb concentrations in mussels were higher in the winter experimental period than in summer (Table 2). In summer, the younger age groups (A and B) achieved maximum Pb concentrations at the same period when dissolved Pb concentrations were the highest. Only the oldest age group showed constant Pb concentration increase until the rain and SE wind event (15-21 July). It is obvious that stress, caused by the transplantation and reflected by the condition index decreases in a first week of both experiments (summer and winter), did not have a significant

influence onto Pb accumulation. Similar to Hg and Cd concentrations in biofouling organisms, the average Pb concentrations were higher in summer than in winter (Table 2). It is interesting that Pb concentrations in biofouling organisms during the winter experiment showed significant correlation with a total Pb quantity in suspended matter. Similar to the mussels, Pb concentrations in biofouling organisms were in a good correlation with dissolved Pb concentrations. The reaction time (bioaccumulation and depuration) for these organisms was slightly faster than for the younger mussels (A and B age groups).

In summer, the oldest mussels (C age group) were able to establish equilibrium with environmental Pb concentrations in a fourth week after the beginning of the experiment, which was one week later than younger age groups (A and B). Bioaccumulation rate in mussels (especially the oldest age group) was higher in winter than in summer (Table 3).

Conclusions: Pb

- Food is the main source of Pb for mussels, but good correlation between dissolved and accumulated Pb suggests that the water might be an important source of this metal (directly or indirectly through the food web)
- Water is the main source of Pb for biofouling organisms
- Mussels accumulate Pb faster in winter (better bioavailability)
- Depuration rate is similar to accumulation rate after initial equilibration period

GENERAL FACTS AND CONCLUSIONS

- Hydro- and meteo- conditions (temperature, air pressure-sea level, wind, rain) significantly influence metal speciation in the water column and consequently availability to the marine organisms.
- Lower dissolved (labile) metal but higher suspended metal (Hg, Cd, Pb) concentrations in winter.
- Higher sedimentation rate and slightly higher organic matter concentration in suspended matter in winter.
- Biofouling organisms accumulate higher metal concentrations in summer (water as the main source).
- Average metal concentrations in mussels are higher in winter (food as the main source).
- Older (bigger) mussels accumulate higher metal concentrations, but slower than younger mussels.
- Mussels accumulate metals faster in winter.
- Transplantation has influence mostly on the youngest mussels.

The results of this study showed clearly the importance of all three compartments (organisms, particulate matter and water) onto the bioavailability of trace metals. Further, biological factors (e.g. age, size) affect trace metal uptake in marine organisms. Also, bioavailability is highly dependent onto meteorological and oceanographic conditions as they influence metal content and speciation in water and suspended matter, plus the metabolic rate and physiologic behaviour of the organism.

Transfer of radionuclides and organic matter in the Rhone delta coastal zone studied with large field-deployed mesocosms

Hervé Thébault¹ and Elisabeth Alliot²

¹Lab. d'Etudes Radioécologiques Continentales et de la Méditerranée, La Seyne/mer, France

²Centre d'Océanologie de Marseille, France

INTRODUCTION

The bioaccumulation factors and the transfer rates of contaminants between the various components of the aquatic ecosystems have been generally determined in lab experiments with small volume aquaria and sometimes in conditions far from those found in the natural environment. Moreover, the food chains used in those experiments are usually very simplified compared to the complexity of interactions controlling the behavior of contaminants in coastal waters (Santschi, 1988). Therefore, the mesocosms (enclosed meso-scale experimental ecosystem) have become widely used as reliable research tools in aquatic ecology (Brinkman *et al.*, 1994). As the ecological realism of the mesocosms is size-dependant, there is a sound interest for large enclosures (Petersen *et al.*, 1999), deployed *in situ* to come closer to natural conditions, especially with an undisturbed sediment compartment (Kraufvelin, 1999). But the optimal implementation, including operation easiness for long term studies, need to be tested first for each marine environment.

The transfer of some artificial radionuclides between the major compartments of an estuarine Mediterranean ecosystem was studied along with the organic matter balance. The field experiments were conducted to provide controlled and reproducible conditions within a global and holistic experimental concept. This isolated portion of the coastal ecosystem allowed observations on the distribution and the transfer factors in the dissolved phase of the water column, particulate matter, filter-feeding organisms (mussels) and sediment.

MATERIALS AND METHODS

The study was carried out in the Anse de Carteau, a shallow area in the Rhone delta (Fig.1). Inflows from rivers in this coastal zone bring nutrients inducing highly productive waters and radionuclides from discharges from several nuclear facilities along the Rhone waterway. Mussel farming was developed, 20 years ago, and has reached a 3000 tons/year production. This high mussel biomass and productivity obviously influence the primary production and the sedimentation processes providing a particular coastal ecosystem with intense fluxes of matter.

Experiments were run in large volume (92 m³) Dacron sail-cloth enclosures (mesocosms) deployed *in situ*, using the local mussel production hanging racks facilities as a support frame. The cubic-shaped enclosures stand higher than the sea surface and are buried in the sediment, allowing only limited flows of water and dissolved substances through the walls.

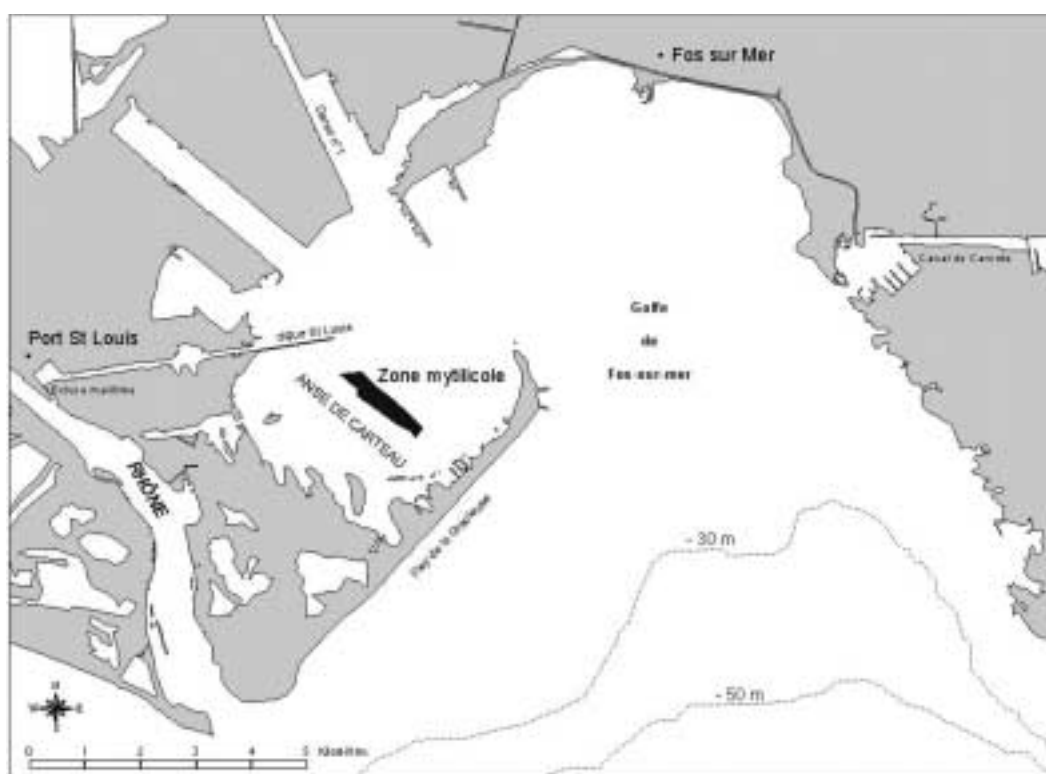

Fig. 1. Study area on the French Mediterranean coast.

The 1998 experiment focused on the behavior of the mesocosm compared to the surrounding waters, and in the 1999 tests, the influence of mussel biomass was studied by comparing the evolution of key parameters within two mesocosms: one containing 80 kg (fresh weight) of mussels and the second without mussel, as a control.

The hydrological parameters (temperature, salinity, dissolved oxygen, pH and turbidity) were recorded continuously (YSI 6920 sensor sonde) inside the mesocosms and in the surrounding waters. Water samples were taken every day for the determination of the ecological parameters such as: nutrients, suspended matter, chlorophyll *a* and phaeopigments, phytoplankton counts.

Organic matter content and radionuclides activity (direct gamma spectrometry) were measured in the water (dissolved and particulate phases), settling particles (sediment trap), biodeposits (mussel faeces trap), mussel soft parts and sediment cores.

RESULTS AND DISCUSSION

Hydrology

The environmental conditions, such as temperature and salinity, evolve on the same pattern outside and inside the mesocosm, but there are fewer variations inside, where rapid changes are lessened both in terms of duration and magnitude (Fig. 2). Concurrently, the evolution of hydrological parameters is very similar in the two mesocosms showing good replicability. Continuous recording of turbidity in the water column shows a difference between the mesocosm with mussels (1) and the second, devoid of molluscs (2). The impact of filtration by mussels on suspended particles can be seen as turbidity decreases and remains at a low level when mussels are present (Fig. 3).

Biological parameters

When compared to the surrounding waters, nutrients concentration and abundance/diversity of phytoplankton in the mesocosm evolve similarly, indicating good ecological realism of the experimental system (Berg *et al.*, 1999). Mesocosm 1 exhibits a lower content in chlorophyll *a* and phaeopigments compared to mesocosm 2, but no drastic decrease was recorded in the meso-

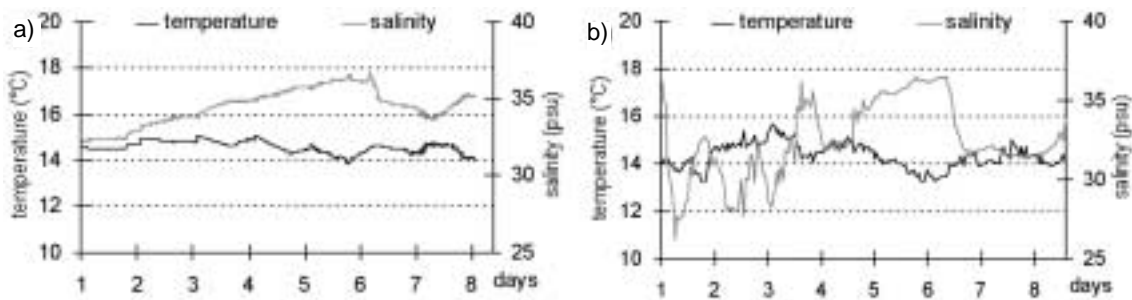

Fig. 2 Time evolution of temperature and salinity inside the mesocosm(a) and in the surroundings waters (b).

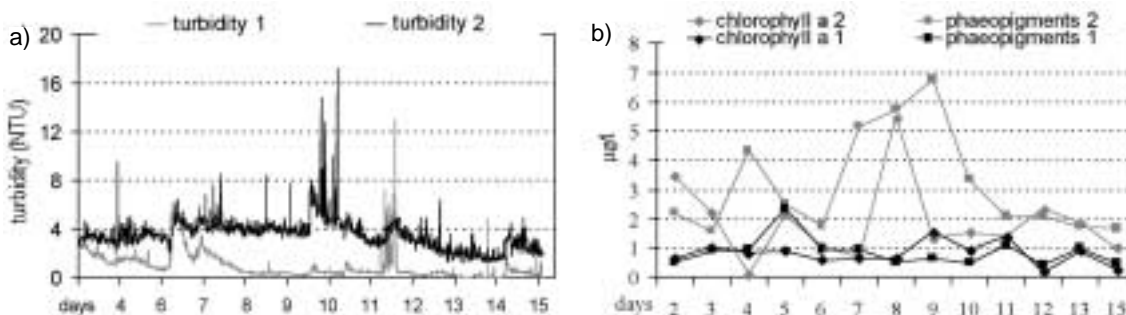

Fig. 3. Evolution of turbidity (a) and chlorophyll (b) in mesocosm 1 (with mussels) and mesocosm 2 (control).

cosm with mussels during the experiment (Fig. 3). The depletion of pigments in the water column is the result of filter-feeders activity (Denis *et al.*, 1999). Conversely, due to turbidity decrease, photosynthetic available radiations (PAR) are higher (in the water column) in the mesocosm 1 and enhance primary production, as long as nutrients are provided by the external medium (slow diffusion through the enclosure walls), mussel excretion and sediment pore water. These results indicate that the mussel biomass increases the productivity of the shallow-water coastal system.

Radionuclides

¹³⁷Cs is the only artificial radionuclide detected by gamma spectrometry in samples from all mesocosm components. The ¹³⁷Cs in the water dissolved phase is stable during the experiments with an average value of 2,3 Bq/m³. Changes in concentration of particulate ¹³⁷Cs (Fig. 4) follow variations in particulate matter (Martin and Thomas, 1990) and distribution factor equilibrium (Kd values ranging from 1300 to 2300). Particulate ¹³⁷Cs, although representing less than 2% of the water column inventory, controls water removal of dissolved ¹³⁷Cs by sinking or filtering

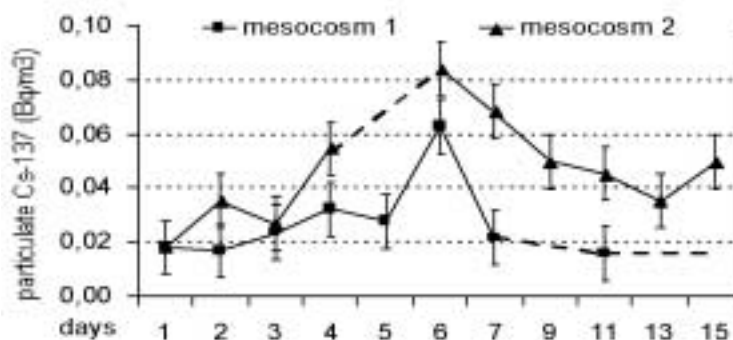

Fig. 4. Evolution of particulate ¹³⁷Cs concentration in mesocosm 1 (with mussels) and mesocosm 2 (control).

processes. The concentration factor value (CF) of ^{137}Cs in mussel is 10, close to values currently reported (AIEA, 1985). The biodeposits (trapped mussel faeces) exhibit a higher cesium content (17 Bq/kg dry weight) than the regular settling particles and the overall transfer factor (or enrichment rate) from the water column equals 7400.

Inventories

The organic matter and radionuclides vertical transport from sea water towards the surface sediment is largely increased by the mussel biomass through settling of mussel faeces (Gontier *et al.*, 1992). For the ^{137}Cs and organic matter, more than 99% of the mesocosm inventory is held in the sediment compartment (Fig. 5), given a mixing depth of 20 cm (Gerino *et al.*, 1994). The sediment represents a sink in the behavior of ^{137}Cs and artificial radionuclides (Padmanabhan *et al.*, 1992) but changes in environmental conditions can possibly lead to some remobilization of ^{137}Cs from the coastal sediment (Förstner et Schoer, 1984), becoming a secondary source and controlling the water column concentration in this shallow area.

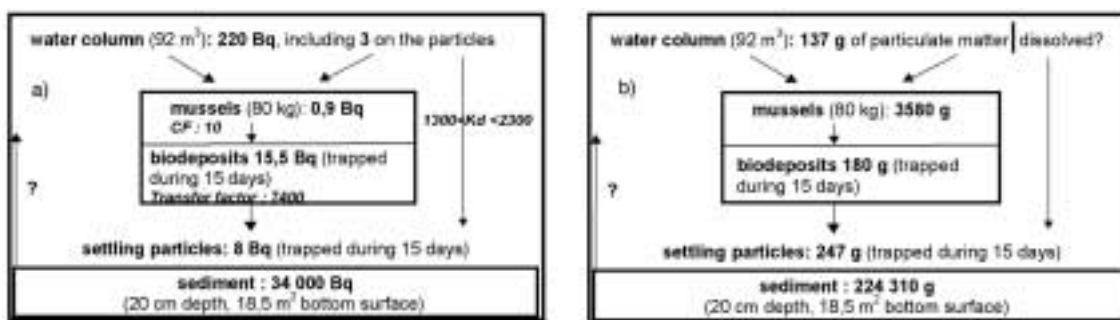

Fig. 5. Inventories of ^{137}Cs (a) and organic matter (b) in mesocosm 1 (with mussels).

CONCLUSION

This preliminary work revealed good operating feasibility of the enclosure and fittings. When compared to the surrounding environment, including for the pattern of phytoplankton communities, the mesocosms show insignificant artifact on ecological variables with more stability on the hydrological conditions. Measurements in large volume enclosures in situ may give realistic and reproducible estimates of exchanges between compartments in a coastal area, useful for future modelling activity. Further work will deal with on possible releases from the sediment, and carbon and nitrogen cycling within the estuarine ecosystem, as reproduced in the field mesocosm.

Acknowledgments

The authors warmly thank Alain Champelovier and Yves Diméglio for skilled field work, Claude Jalong for chilly diving operations, Albert Castejon, mussel farmer, for everyday support and Joseph Ronny for his craftsmanship in the design and making of sail-cloth enclosures.

Réponse de certains paramètres biochimiques chez la moule méditerranéenne *Mytilus galloprovincialis* à la pollution métallique

Abdellatif Moukrim

*Laboratoire de recherche Eau et Environnement, Département de Biologie,
Faculté des Sciences, Université Ibn Zohr, Agadir, Maroc.*

INTRODUCTION

Au Maroc, le milieu marin joue un rôle socio-économique de grande envergure (tourisme et pêche). Cependant, ce milieu reçoit les rejets d'eaux usées domestiques et industrielles, souvent sans traitement préalable, de la totalité des villes côtières marocaines (en plus des apports telluriques via les fleuves, rivières et oueds). Ces eaux sont chargées en hydrocarbures, pesticides, métaux lourds, etc.

Si certaines études ont porté sur l'évaluation et la caractérisation des polluants dans le milieu marin dans notre pays, celles qui s'intéressent à leur impact sur les différents écosystèmes restent plutôt rares et fragmentaires. D'une manière générale, les travaux relatifs à l'évaluation du niveau de pollution ont porté surtout sur les métaux lourds (Cheggour *et al.*, 1999, 2001; Chafik *et al.*, 2001; Moukrim *et al.*, 2000) et ont montré que les concentrations enregistrées ne dépassent pas les normes admises. Néanmoins, certains secteurs sont plus touchés par cette pollution que d'autres. Il s'agit surtout de sites qui reçoivent les effluents des unités industrielles de traitement des phosphates (Jorf Lasfar et Safi sur la côte atlantique centre) et à moindre degré, ceux situés à proximité des concentrations industrielles dans la région Casablanca-Mohammedia. Ces études montrent aussi que les sites à upwelling présentent des concentrations relativement élevées en certains métaux, particulièrement le cadmium (Moukrim *et al.*, 2000).

Dans cet article, nous présentons une synthèse de certains de nos travaux concernant les effets biologiques des polluants, particulièrement les métaux lourds, chez les moules. Ces travaux ont été conduits en vue d'utiliser la réponse des différents paramètres biologiques dans la bio-surveillance des écosystèmes côtiers (Najimi *et al.*, 1997, Kaaya *et al.*, 1999, Moukrim *et al.*, 1999). Le choix des moules pour ces recherches réside dans le fait que ces organismes sont filtreurs, sédentaires, bioaccumulateurs, faciles à récolter, largement répartis sur les côtes marocaines, et très utilisés comme espèces sentinelles par plusieurs auteurs et dans plusieurs programmes internationaux de biosurveillance des écosystèmes marins (Biomar, MEDPOL, etc.). Quant au choix de la réponse biologique de ces mollusques aux polluants, comme outil d'évaluation de l'état de santé des écosystèmes, il est motivé par le fait qu'il s'agit de techniques simples, rapides, peu coûteuses qui, contrairement aux techniques chimiques, renseignent sur les effets biologiques dus aux perturbations du milieu et ne nécessitent pas d'équipements sophisti-

qués. De plus, elles constituent les réponses les plus précoces aux effets des contaminants, et de ce fait, permettent de détecter très tôt l'impact des polluants sur les organismes exposés, donc de prévenir, à long terme, toute détérioration des écosystèmes étudiés. Ces techniques sont bien connues (cf. Narbonne *et al.*, 1991; Labrot *et al.*, 1996; Regoli et Principato, 1995 et Burgeot *et al.*, 1996).

MATÉRIEL ET MÉTHODES

Nos travaux ont porté sur les deux espèces de moules vivant sur les côtes marocaines : la moule africaine *Perna perna* et la moule méditerranéenne *Mytilus galloprovincialis*. Nous nous limitons ici à ceux réalisés sur la deuxième espèce. Dans la baie d'Agadir, nous avons retenu deux sites : un site de référence (Cap Ghir, 45 km au nord d'Agadir), loin de toute activité humaine, et un site pollué (Anza, 5 km au nord d'Agadir) qui reçoit les rejets d'une zone industrielle (cimenteries, huileries, conserveries, etc.). Ce dernier a fait l'objet de deux études qui ont révélé la présence de métaux lourds dans les rejets (Bari, 1994) et dans le sédiment du milieu récepteur (Id Halla, 1997).

Nous nous sommes intéressés chez les moules aux paramètres biologiques suivants : l'Acétylcholinestérase (AChE), le Malondialdéhyde (MDA), la Catalase (CAT) et la Glutathion-S-Transférase (GST).

Le protocole expérimental, la méthodologie et la description des analyses et techniques utilisées dans nos recherches sont détaillées dans les différentes publications de notre équipe de recherche et les thèses soutenues dans notre laboratoire (Najimi, 1997; Id Halla, 1997; Kaaya, 2002). Toutefois, pour chaque expérience présentée dans cet article, un rappel du protocole expérimental est donné comme introduction aux résultats.

RÉSULTATS ET DISCUSSION

Les métaux lourds sont des contaminants majeurs du milieu marin. Certains, dits oligo-éléments (Fe, Cu, Zn, Mn, Mo, Co), sont indispensables au fonctionnement des métallo-enzymes, mais ils peuvent devenir toxiques à des concentrations trop élevées. D'autres, comme le Cd, le Hg et le Pb, sont connus seulement pour leurs effets toxiques (Viarengo, 1985). Les métaux lourds peuvent altérer la physiologie des organismes de plusieurs manières, soit : i) par liaison aux biomolécules solubles (enzymes, ADN) ou membranaires (phospholipides), ii) en réagissant avec les groupements thiols (SH) des biomolécules, iii) en altérant le métabolisme cellulaire (tel que le transport transmembranaire, la stabilité lysosomale ou la réplication de l'ADN) (Goering *et al.*, 1987; Viarengo, 1989).

A. L'Achétylcholinestérase

L'AChE a été considérée par plusieurs auteurs comme étant un indicateur spécifique de l'exposition aux pesticides organophosphorés et carbamates (par exemple Hill et Fleming, 1982; Day et Scott, 1990). Cependant, d'autres travaux ont décrit une perturbation de l'activité AChE en présence de certains métaux traces (Thaker et Haritos, 1989a, b; Devi et Fingerman, 1995; Labrot *et al.*, 1996).

Dans ce paragraphe, nous présentons une synthèse des travaux réalisés, au laboratoire et *in situ*, sur l'effet de certains métaux traces sur l'AChE chez *Mytilus galloprovincialis*.

1. Au laboratoire

Nos investigations ont consisté en une étude comparative pour identifier l'effet des métaux (Cd, Cu, Fe et Zn) directement sur l'enzyme (exposition *in vitro*) ou après une modulation métabolique (exposition *in vivo*). L'ensemble de ces études a été réalisé sur l'animal entier afin de mettre en évidence les changements au niveau de l'individu. Le choix des métaux testés est basé sur plusieurs critères, entre autres, leur effet inhibiteur sur l'activité AChE démontré par plusieurs études (Abou-Donia et Mensel, 1967; Galzigna *et al.*, 1969; Olson et Christensen, 1980; Christensen *et al.*, 1982; Bocquené *et al.*, 199; Devi et Fingerman, 1995). Ces métaux sont aussi largement utilisés dans certaines activités industrielles de la région et leur présence a été signalée dans les effluents de la zone industrialisée d'Anza (Bari, 1994). L'étude de l'effet *in vitro* de

chacun des métaux traces sur l'activité AChE a été réalisée à des concentrations comprises entre 10^{-7} et 10^{-2} M.

Les résultats montrent que chez *M. galloprovincialis* des différences significatives par comparaison aux témoins, sont observées quand l'un des quatre métaux testés est ajouté dans le milieu réactionnel. Pour le cadmium et le zinc (Fig. 1), une inhibition significative de l'activité AChE est notée uniquement à 10^{-2} M ($p < 0,01$, $n=6$) et 10^{-3} M ($p < 0,05$, $n=6$). Pour les faibles concentrations testées, 10^{-5} et 10^{-7} M, bien qu'une diminution de 13 % de l'activité enzymatique ait été observée à 10^{-7} M de Cd, elle demeure néanmoins non significative.

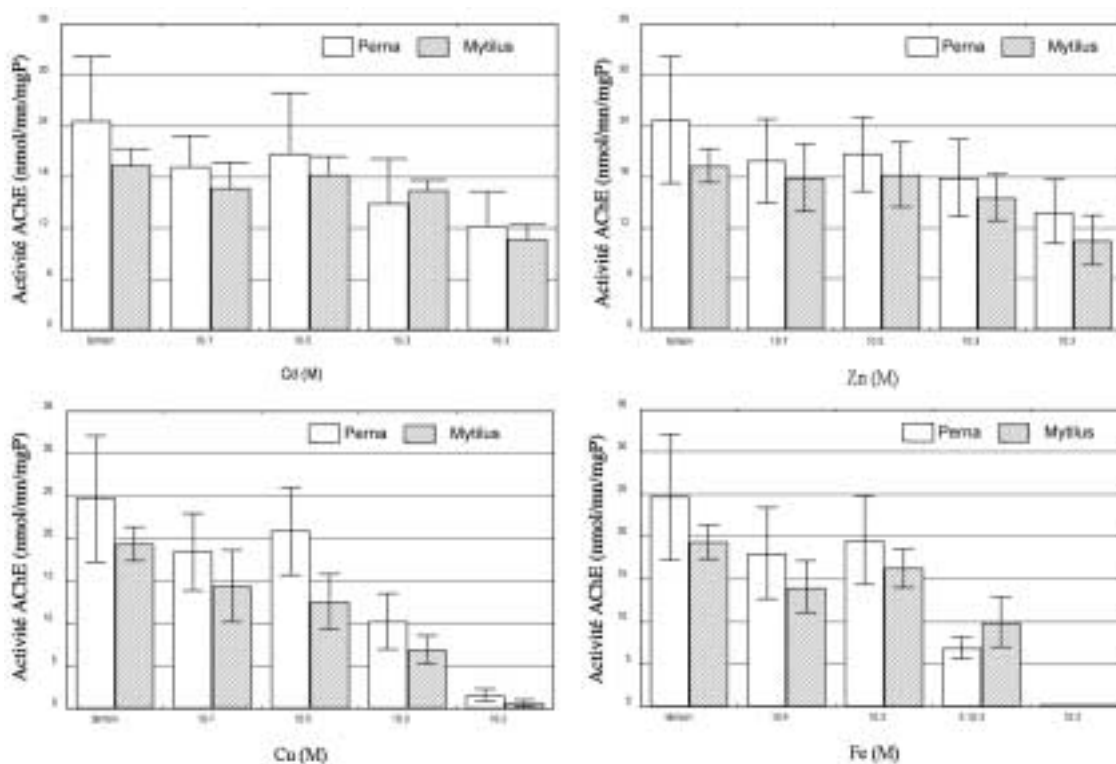

Fig. 1. Effet *in vitro* du cadmium, zinc, cuivre et fer sur l'activité AChE chez *M. galloprovincialis* de la station Cap Ghir. (L'effet des quatre métaux sur l'AChE de la moule *P. perna* originaire du même site est donné dans le graphique, à titre comparatif).

Dans le cas du cuivre, le métal exerce une inhibition totale de l'activité de l'enzyme à 10^{-2} M (Fig. 1). Cet effet inhibiteur est observé aussi pour les autres concentrations testées (même la plus faible dose utilisée : 10^{-7} M). Le cuivre semble donc inhiber fortement l'activité AChE comparé au cadmium et au zinc. L'inhibition maximale étant de 97 % à 10^{-2} M contre 26 % à 10^{-7} M. De même pour le fer, l'inhibition est significative à la plus faible concentration testée (10^{-4} M) ($p < 0,01$, $n=6$) et est totale à 10^{-2} M.

La détermination de la CI_{50} , qui représente la molarité du composé testé dans le milieu réactionnel provoquant une inhibition de 50 % de l'activité enzymatique, nous a permis de comparer la toxicité du Cd, Cu, Zn et Fe chez *M. galloprovincialis*. Ses valeurs pour les quatre métaux sont respectivement : $1,0 \cdot 10^{-2}$; $3,0 \cdot 10^{-3}$; $1,0 \cdot 10^{-2}$ et $4,8 \cdot 10^{-3}$. Le cuivre présente la CI_{50} la plus faible ($3 \cdot 10^{-3}$ M) et donc la toxicité la plus forte. Il est suivi par le Fe, le Cd puis le Zn qui montre la CI_{50} la plus élevée (10^{-2} M) et par conséquent la plus faible toxicité.

Peu d'études se sont intéressées à l'effet *in vitro* des métaux lourds. Olson et Christensen (1980) ont déterminé l'ordre d'effet de plusieurs métaux lourds sur l'activité AChE de poissons et ont démontré que le cuivre et le cadmium ont un fort pouvoir inhibiteur sur cet enzyme. Thaker et Haritos (1989a, b) ont mis en évidence l'effet inhibiteur *in vitro* du mercure et du cadmium sur l'activité estérasique. Une inhibition de 50 % de cette activité a été enregistrée à 3,12 mM et

30 mM respectivement pour les deux métaux. Bocquené *et al.* (1990) ont observé que les CuSO_4 (10^{-3} M), CuCl_2 ($5 \cdot 10^{-5}$ M) et Zn (10^{-3} M) entraînent une inhibition quasi totale de l'activité AChE et que le CdCl_2 (10^{-3} M) induit une perte de 50% de cette activité enzymatique. Plus récemment, Labrot *et al.* (1996) ont décrit un effet inhibiteur du plomb et de l'uranium *in vitro* sur l'AChE d'un bivalve d'eau douce *Corbicula* sp., d'un annélide *Eisenia fetida* et d'un poisson d'eau douce *Brachydanio rerio* à des concentrations allant de 2,5 à 2500 mg/l.

Les valeurs de la CI_{50} déterminées dans le présent travail montrent que la CI_{50} la plus faible est celle du Cu suivie par celle du Fe confirmant ainsi la forte toxicité de ces deux métaux.

L'inhibition *in vitro* de l'activité AChE peut être expliquée par les interactions de ces métaux avec les groupements fonctionnels des protéines enzymatiques tels les groupements imidazoles, sulfhydriles, carboxyles et peptidiques et/ou leurs substrats. Selon Viarengo (1985), la toxicité des métaux vis-à-vis des enzymes peut s'expliquer par la liaison du métal toxique à un site désactivé de la molécule. L'interaction avec ces groupements pourrait ainsi entraîner un changement conformationnel de l'enzyme et par conséquent empêcher la liaison du substrat avec le site actif.

2. Sur le terrain

La Figure 2 illustre l'évolution de l'activité AChE chez *M. galloprovincialis* dans les sites pollués et de référence. On constate que l'activité est significativement réduite à Anza par comparaison au Cap Ghir. Ceci est observé pour la quasi-totalité des prélèvements réalisés le long des deux cycles annuels.

La corrélation entre l'inhibition de l'activité AChE et le gradient de pollution *in situ* a été rapportée également par Narbonne *et al.* (1991) chez des moules *M. galloprovincialis* et des poissons *Serranus scriba* et *Serranus cabrilla* prélevés dans des sites pollués de Méditerranée.

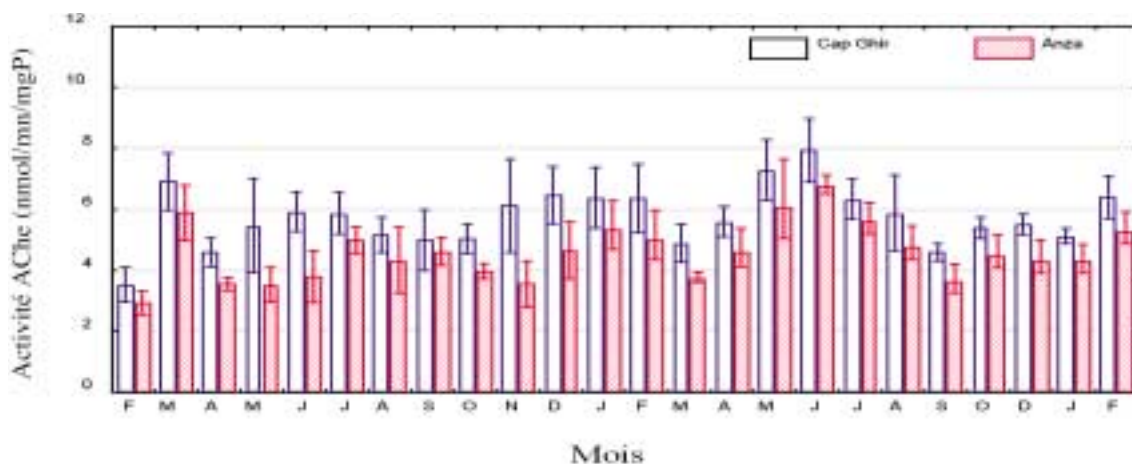

Fig. 2. Variation mensuelle de l'activité AChE chez *M. galloprovincialis* dans le site de référence Cap Ghir et le site pollué Anza durant deux cycles annuels.

L'inhibition de l'activité acétylcholinestérase mesurée chez les animaux de la station polluée pourrait être due à la présence dans le milieu de composés ayant un pouvoir inhibiteur vis-à-vis des cholinestérases. La nature des contaminants présents dans la station polluée Anza est peu étudiée. Toutefois, et même si plusieurs travaux réalisés dans d'autres régions ont souligné le fort pouvoir inhibiteur des pesticides organophosphorés et carbamates sur l'activité AChE qui a été considérée par certains auteurs comme étant un indicateur exclusif d'exposition à ces composés (Hill et Fleming, 1982; Galgani et Bocquené, 1989; Day et Scott, 1990), il semblerait improbable que l'inhibition de l'enzyme observée chez les animaux de la zone industrielle d'Anza soit due à une contamination par les pesticides du fait que les activités liées à l'agriculture sont négligeables dans cette zone. Dans la baie d'Agadir et particulièrement le site d'Anza, les travaux concernant la détermination de la nature des contaminants sont rares à l'exception des travaux de Bari (1994) qui a décrit la présence de Cd, Cu, Pb et Zn à des concentrations de l'ordre de 0,17 - 0,159 - 0,2 et 1,67 mg/l respectivement dans des effluents de la station polluée Anza. De plus, les données chimiques disponibles sur le sédiment des deux stations d'étude font apparaître des teneurs en

cuiivre, cadmium, zinc, manganèse et nickel à Anza qui sont nettement supérieures à celles relevées à Cap Ghir (Id Halla, 1997).

Les corrélations des niveaux de Cd, Cu et Zn déterminés dans les tissus mous des moules et l'activité AChE mesurée dans la fraction S9 des animaux prélevés à Anza pendant la période de janvier à décembre 1995 montre des corrélations négatives significatives ($p < 0,01$) pour les taux de Cu et Zn dans les tissus des mollusques et l'activité AChE ($r = -0,556$, $n = 44$ et $-0,499$, $n = 36$ respectivement pour Cu et Zn). Comme pour la majorité des enzymes, à certaines concentrations, les métaux sont capables d'inhiber l'activité AChE aussi bien *in vivo* qu'*in vitro*. Ainsi, il est raisonnable d'affirmer que ces métaux sont à l'origine de l'inhibition de l'activité AChE au niveau des moules d'Anza (au moins en partie). Cette réduction exercée par les métaux pourrait être due à un changement conformationnel au niveau des acétylcholinestérases. Un tel changement a été observé pour l'effet de certaines formes organomercuriques sur l'AChE du poisson *Torpedo californica* (Kreimer *et al.*, 1994).

B. La peroxydation lipidique

Les radicaux libres peuvent être impliqués dans les processus biologiques fondamentaux tels que la phagocytose, la biosynthèse des prostaglandines et thromboxanes et diverses autres oxydations physiologiques. Cependant, plusieurs études ont montré la capacité de certains contaminants à engendrer une production accrue de radicaux libres. Ces derniers ne sont plus neutralisés du fait que les systèmes de défense sont débordés et sont alors capables d'attaquer les constituants cellulaires et induire des lésions irréversibles.

Dans le cadre de nos études, et afin d'évaluer la réponse de la peroxydation lipidique à la pollution, nous nous sommes intéressés à deux paramètres : i) l'activité GST, enzyme de la phase II de la conjugaison du métabolisme des xénobiotiques, et ii) le taux du MDA, produit secondaire engendré par de la peroxydation lipidique qui se forme lors de l'attaque des lipides polyinsaturés (de la famille n-6) par des espèces réactives de l'oxygène générées par certains contaminants (HAP, PCB, pesticides, métaux lourds).

Comme pour l'AChE, nos travaux relatifs à ces deux paramètres ont consisté en expériences au laboratoire et sur le terrain. Seules nos investigations *in situ* sont présentées dans cet article. Il s'agit d'un suivi mensuel (de février 1995 à février 1997) chez les moules des sites d'Anza (pollué) du Cap Ghir (de référence).

1- Glutathion S-transférases (GST)

Les résultats montrent que l'enzyme est significativement induite chez les animaux originaires du site pollué (Fig. 3). Des résultats similaires ont été rapportés par Burgeot *et al.* (1996) dans le foie des *Mullus barbatus* prélevés le long des côtes françaises et espagnoles dans des sites contaminés par des rejets d'eaux usées domestiques et industrielles, et par Fitzpatrick *et al.* (1997) dans les branchies des moules *Mytilus edulis* collectées sur les côtes sud d'Irlande. L'induction de la GST a été également mise en évidence par des expériences de transplantation ou de

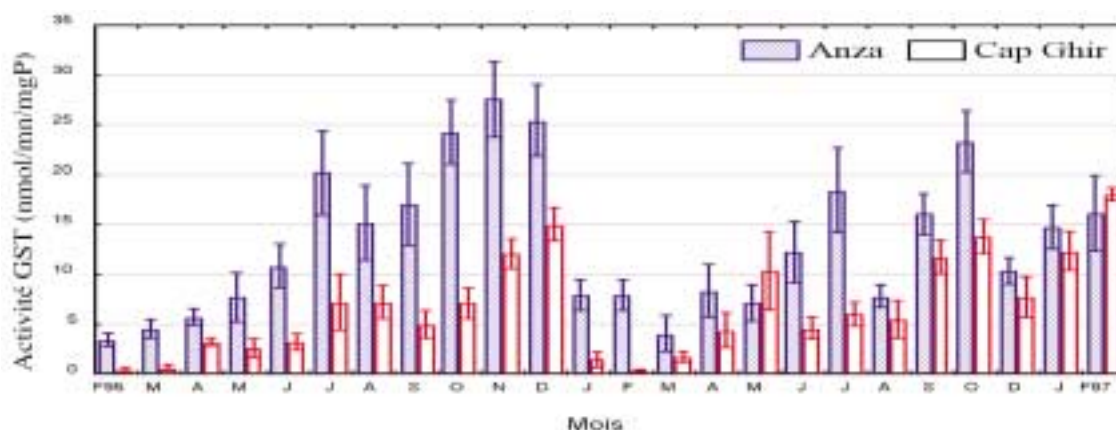

Fig. 3. Variation mensuelle de l'activité GST chez *M. galloprovincialis* récoltées sur le site de référence Cap Ghir et le site pollué Anza.

“caging”. Ainsi, Clérandeau (1996) a montré que l’activité GST chez *Corbicula fluminea* a une tendance générale à augmenter avec les niveaux de pollution à la suite d’une transplantation des animaux dans un site pollué. Le même résultat a été obtenu par Fitzpatrick *et al.* (1997) à la suite de la transplantation de *M. edulis* d’un site de référence à un site pollué. Inversement, la transplantation de *M. edulis* d’un site pollué à un site non pollué conduit à une diminution de l’activité GST des animaux transplantés qui devient comparable à celle des animaux du site non pollué.

2- Malondialdehyde (MDA)

In situ, l’évolution comparative de la teneur en MDA chez *M. galloprovincialis* de la baie d’Agadir montre des valeurs significativement plus importantes chez les animaux du site pollué par rapport à ceux du site de référence, durant pratiquement tout le cycle annuel (Fig. 4). De plus, dans la station Anza, les teneurs en MDA maintenues à des taux élevés pendant la période estivale seraient liées aussi à l’activité industrielle intense pendant cette période. Ces résultats ont été observés aussi bien par El Hamidi (1995) que Chahidi (1997) de notre laboratoire. Le taux important de MDA détecté chez les animaux de la station polluée seraient dû à la pollution par les eaux usées domestiques et les rejets industriels (la cimenterie, les huileries, le port) qui sont chargés en contaminants et qui sont rejetés en mer, sans aucun traitement préalable. Les contaminants peuvent être de nature variés (métaux, détergents, polluants organiques, etc.) et seraient responsables d’une peroxydation lipidique intense chez les animaux de cette station. Comme indiqué ci-dessus, la présence de métaux lourds (cuivre, cadmium, zinc, manganèse et nickel) à Anza a été signalée par Bari (1994) et Id Halla (1997), avec des concentrations relativement importantes par rapport à celles du site de référence. On pourrait attribuer aux métaux l’augmentation du taux de MDA chez les mollusques de cette station. Narbonne *et al.*, (1991) rapportent que les métaux ont un pouvoir initiateur de la lipoperoxydation. Halliwell et Gutteridge (1990) ont montré que les métaux de transition participent à la génération de formes actives de l’oxygène pour produire d’autres radicaux fortement réactifs.

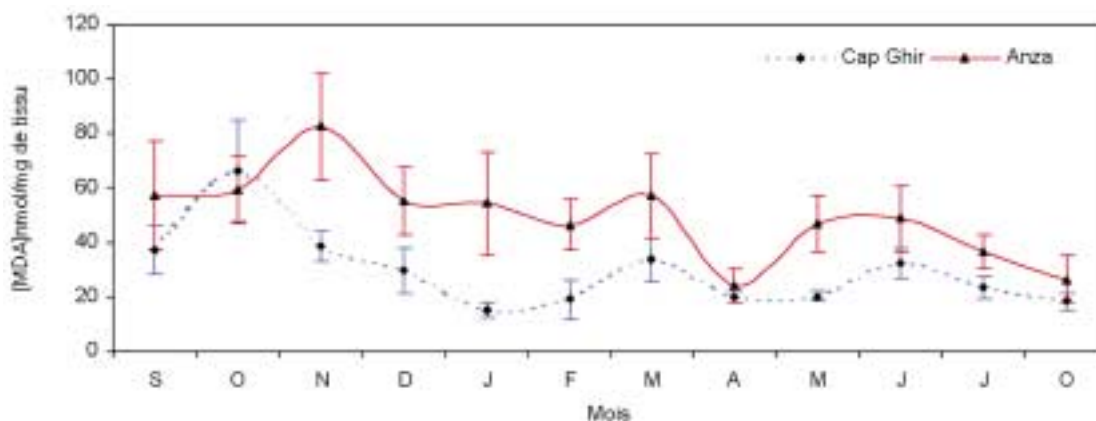

Fig. 4 . Variation mensuelle de la teneur en MDA chez les moules récoltées sur le site de référence Cap Ghir et le site pollué Anza.

CONCLUSION

L’ensemble des résultats de ces travaux réalisés par notre équipe sur la moule méditerranéenne *Mytilus galloprovincialis* et la moule africaine *Perna perna* dans l’écosystème de la baie d’Agadir nous permettent de conclure que pour l’évaluation, le suivi et la biosurveillance de l’état de santé des côtes marocaines, ces mollusques peuvent être retenus comme espèces sentinelles en utilisant les paramètres biochimiques. C’est dans ce sens que nous avons réalisé en 2001 et 2002 deux campagnes de prélèvements de moules sur l’ensemble des côtes de notre pays, en prêtant une attention particulière aux sites pollués. Les échantillons ont fait l’objet d’analyses de polluants et de paramètres biochimiques. Les résultats sont en cours de traitement. Ils permettront probablement, outre l’application des biomarqueurs dans l’évaluation de l’état de l’environnement des autres régions du Maroc, de déterminer la réponse des paramètres biochimiques en fonction de l’écosystème et des différentes sources de pollution.

Mercury, cadmium, lead and zinc bioaccumulation in soft-bottom marine macrophytes from the East coast of Spain

Carles Sanchiz¹, Antonio M. García-Carrascosa¹ and Agustín Pastor²

¹ Department of Animal Biology, Marine Biology Laboratory, Faculty of Biology, University of València, Burjassot (València), Spain

² Department of Analytical Chemistry, Faculty of Chemistry, University of València, Burjassot (València), Spain

We have studied in recent years (Sanchiz *et al.*, 1998, 1999, 2000, 2001) mercury, cadmium, lead and zinc bioaccumulation in three seagrasses (*Posidonia oceanica*, *Cymodocea nodosa* and *Zostera noltii*), a brackish-water phanerogam (*Ruppia cirrhosa*) and a Chlorophycean alga (*Caulerpa prolifera*). The species were collected from 17 sampling stations located along the Mediterranean Spanish coast (Fig. 1). In these plants the metal distribution among different anatomical fractions has been studied, and the metal concentrations in the plants have been related to metal contents in the sediment and to some physico-chemical characteristics of the sediment (organic matter, fine fraction (particles <63µm), carbonates and cation exchange capacity (CEC)).

Only in the case of Hg were some values below the detection limit which was 8 ng·g⁻¹ for plants and 4 ng·g⁻¹ for sediments. Values below the detection limit have been considered as one half the value of the detection limit. All the variables have been log-transformed previously to the statistical analyses in order to observe their requirements.

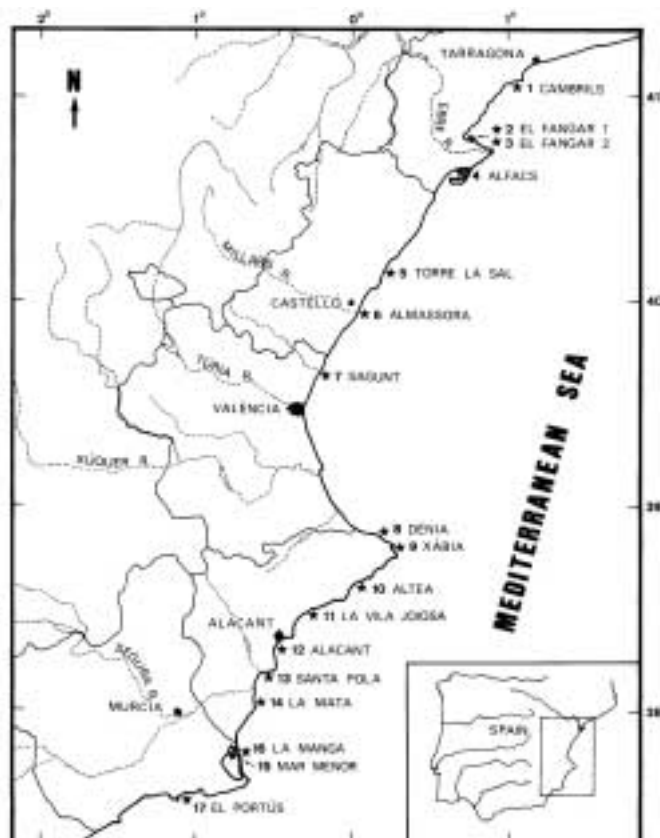

Fig. 1. Map of sampling stations.

Levels of metals were low in most of the sampling stations and similar to those found by other authors in uncontaminated zones (e.g. UNEP/FAO/WHO, 1987; Costantini *et al.*, 1991; Catsiki and Bei, 1992; Warnau *et al.*, 1995; Gnassia-Barelli *et al.*, 1995; Pergent-Martini, 1998; Nicolaidou and Nott, 1998; Pergent and Pergent-Martini, 1999; Campanella *et al.*, 2001). Certain locations, however, showed some degree of contamination (Cambrils, Almassora, Alacant, Mar Menor and El Portús).

In the sediment, an important correlation is found between organic matter, fine fraction and CEC. Cadmium, lead and zinc concentrations of the sediment are also correlated to each other, indicating a geochemical association of these elements. In turn, the three metals are related to organic matter and CEC, suggesting a higher retention of these elements in the sediment with increasing values of these variables.

The distribution of the metals among the different parts of the plants was different for the five species as reflected in Figure 2. In *Posidonia oceanica*, Cd and Zn were accumulated to a higher degree in the leaves, and Pb in the roots. In *Cymodocea nodosa*, the four metals were found in higher concentrations in the leaves. This distribution has been also observed by other authors (e.g. Catsiki and Bei, 1992; Sanchiz *et al.*, 1990; Warnau *et al.*, 1995). In *Z. noltii* and *R. cirrhosa*, the highest concentrations of Hg, Cd and Pb were found in the roots, whereas Zn was equally distributed between roots and leaves. The rhizomes of *C. nodosa* showed higher contents of Zn than the roots, suggesting a translocation of Zn towards this part. Also the uniform distribution of Zn among the anatomical fractions of *R. cirrhosa* suggests some transport of this element, an essential trace element in plants although few studies concern the translocation of Zn in marine phanerogams [Lyngby and Brix (1982) for *Zostera marina*, Schroeder and Thorhaug (1980) for *Thalassia testudinum*].

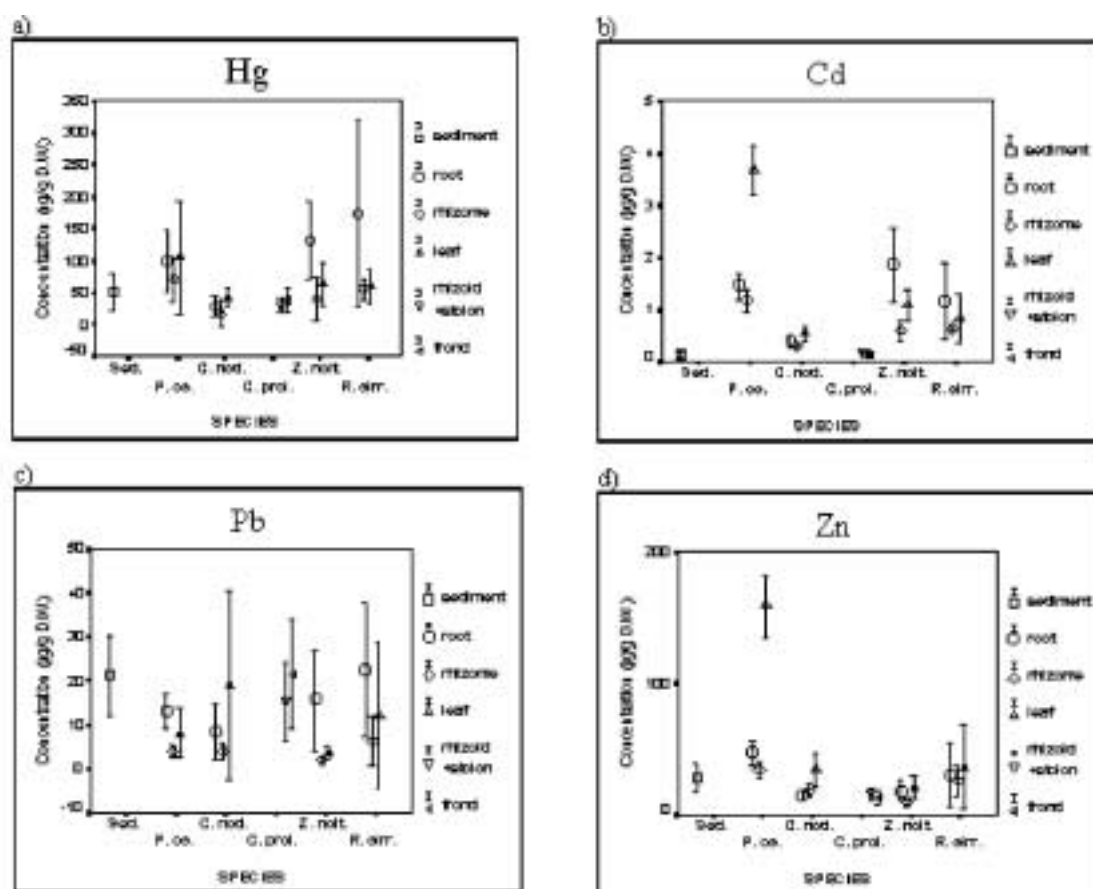

Fig. 2. Mean \pm 2 standard errors for the concentrations of a) Hg, b) Cd, c) Pb, and d) Zn in different soft-bottom marine macrophytes. P. oc. = *Posidonia oceanica*, C. nod. = *Cymodocea nodosa*, C. prol. = *Caulerpa prolifera*, Z. nolt. = *Zostera noltii*, and R. cirr. = *Ruppia cirrhosa*. An outlier value for *Posidonia oceanica* leaves is not included in Cd and Zn graphs.

In *C. prolifera* rhizoids+stolons and fronds showed similar metal concentrations, indicating an appreciable mobility of the metals, probably due to the absence of internal cell walls.

The five species varied in their bioaccumulation capacities except for lead which reached were very similar levels in all five species.

For the phanerogams the relative bioavailability of the metals from the sediment was: Cd > Hg = Zn > Pb. As pointed out by previous authors, the low bioavailability of lead from sediments is due to its strong binding to the organic matter and other components. In the alga the four elements showed similar concentrations to those in the sediment.

Mercury and zinc concentrations in *P. oceanica*, in *C. nodosa* and in *C. prolifera* are usually significantly correlated to those in the sediment (alone or normalized with respect to the physico-chemical characteristics) (Table 1; Fig. 3). This suggests that these species reflect in their tissues the concentrations of these metals in the environment. For Pb only *C. prolifera* fractions were correlated to the Pb content of the sediment. For Cd no significant correlations were obtained.

The concentration factors of the metals in the plants with respect to sediment were usually negatively correlated with the fine fraction, organic matter and CEC of the sediment for Hg, Pb and Zn in *Posidonia* and in *Cymodocea* and for Hg and Zn in *Caulerpa* (Table 2). This suggests that these variables of the sediment increase the retention of these metals in the sediment and reduce their availability to the plants. Several authors also found that organic matter contents and CEC of the sediment caused a decrease in metal bioavailability to brackish-water or freshwater macrophytes (Breteler *et al.*, 1981; Coquery and Welbourn, 1995; Schierup and Larsen, 1981).

Stepwise multiple regression analyses yielded the results shown in Table 3. The Hg concentrations in leaves and roots of *Posidonia oceanica* are explained by the Hg concentration of the

Table 1.. Pearson correlation coefficients between the metal concentration in the plant fraction and the metal concentration in the sediment, alone or normalized with respect to the physico-chemical characteristics of the sediment (¹⁰log-transformed variables).

| species: | <i>Posidonia oceanica</i> (n=10) | | | <i>Cymodocea nodosa</i> (n=11) | | | <i>Caulerpa prolifera</i> (n=10) | |
|----------|----------------------------------|--------|----------|--------------------------------|-------|----------|----------------------------------|-------------------|
| | fraction: | roots | rhizomes | leaves | roots | rhizomes | leaves | rhizoids+ stolons |
| Hg | 0,66* | 0,41 | 0,79** | 0,60* | 0,38 | 0,65* | 0,77** | 0,88** |
| Hg/ff | 0,82** | 0,51 | 0,82** | 0,34 | 0,37 | 0,28 | 0,71* | 0,74* |
| Hg/om | 0,88** | 0,57 | 0,94*** | 0,68* | 0,72* | 0,61* | 0,64* | 0,57 |
| Hg/CEC | 0,82** | 0,49 | 0,92*** | 0,70* | 0,60 | 0,69* | 0,76* | 0,83** |
| Hg/carb | 0,71* | 0,42 | 0,83** | 0,64* | 0,42 | 0,73* | 0,81** | 0,93*** |
| Cd | 0,09 | -0,03 | 0,03 | -0,40 | -0,07 | -0,41 | 0,41 | 0,15 |
| Cd/ff | -0,36 | 0,14 | 0,30 | -0,02 | 0,25 | 0,07 | 0,06 | -0,03 |
| Cd/om | -0,51 | -0,22 | 0,42 | -0,05 | -0,01 | 0,01 | -0,22 | -0,15 |
| Cd/CEC | -0,35 | -0,18 | 0,51 | -0,33 | -0,11 | -0,30 | 0,04 | -0,02 |
| Cd/carb | -0,01 | -0,32 | 0,36 | -0,32 | -0,07 | -0,38 | 0,43 | 0,07 |
| Pb | -0,18 | 0,36 | 0,14 | 0,28 | 0,12 | 0,46 | 0,66* | 0,71* |
| Pb/ff | 0,57 | 0,63 | 0,13 | 0,06 | -0,04 | 0,09 | 0,40 | 0,17 |
| Pb/om | 0,53 | 0,57 | 0,24 | 0,33 | 0,29 | 0,22 | -0,05 | -0,20 |
| Pb/CEC | 0,55 | 0,80** | 0,30 | 0,52 | 0,42 | 0,49 | 0,42 | 0,19 |
| Pb/carb | 0,13 | 0,44 | 0,36 | 0,30 | 0,28 | 0,45 | 0,71* | 0,65* |
| Zn | 0,67* | 0,40 | 0,36 | 0,44 | 0,50 | 0,60* | 0,83** | 0,77** |
| Zn/ff | 0,07 | 0,65* | 0,49 | 0,43 | -0,15 | 0,10 | 0,56 | 0,35 |
| Zn/om | 0,25 | 0,74* | 0,56 | 0,31 | -0,13 | 0,13 | 0,18 | -0,06 |
| Zn/CEC | 0,48 | 0,86** | 0,78** | 0,61* | 0,25 | 0,53 | 0,64* | 0,39 |
| Zn/carb | 0,72* | 0,46 | 0,44 | 0,39 | 0,52 | 0,55 | 0,81** | 0,69* |

(ff: fine fraction: % of sediment particles < 63 μm; om: % of organic matter; CEC: cation exchange capacity (meq/100g); carb: % of carbonates; n: number of samples; significance levels: * P < 0.05, ** P < 0.01, *** P < 0.001).

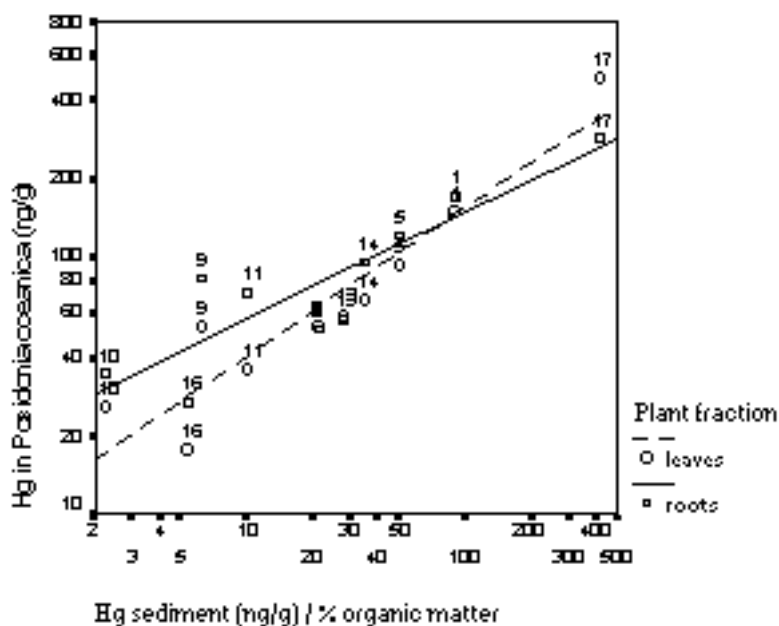

Fig. 3. Significant linear regression between mercury concentrations in *Posidonia oceanica* and in the sediment, normalized with respect to the organic matter content. Labels for the data points refer to sampling sites (Fig. 1).

sediment and by the organic matter of the sediment. The Hg concentration in the fronds of *Caulerpa prolifera* is explained by the Hg concentration in the sediment and by the carbonate content of the sediment.

From the results obtained we consider that *Posidonia oceanica* and *Cymodocea nodosa* would be considered good biomonitors of metal contamination in the Mediterranean Sea, with their leaves the best fraction for the determination of metal concentrations.

Table 2. Pearson correlation coefficients between the concentration factor of the metal in the plant fraction with respect to the sediment (metal concentration in plant / metal concentration in the sediment) and the physico-chemical characteristics of the sediment (¹⁰log-transformed variables).

| | | <i>Posidonia oceanica</i> (n=10) | | | <i>Cymodocea nodosa</i> (n=11) | | | <i>Caulerpa prolifera</i> (n=10) | |
|----|------|----------------------------------|----------|--------|--------------------------------|----------|--------|----------------------------------|--------|
| | | roots | rhizomes | leaves | roots | rhizomes | leaves | rhizoids+ stolons | fronds |
| Hg | ff | -0,66* | -0,52 | -0,68* | -0,47 | -0,53 | -0,48 | -0,56 | -0,49 |
| | om | -0,60 | -0,45 | -0,71* | -0,77** | -0,81** | -0,72* | -0,66* | -0,57 |
| | CEC | -0,50 | -0,32 | -0,64* | -0,74** | -0,82** | -0,70* | -0,55 | -0,50 |
| | carb | 0,00 | 0,15 | -0,12 | 0,28 | 0,22 | 0,25 | 0,03 | -0,07 |
| Cd | ff | 0,37 | -0,01 | -0,22 | -0,17 | -0,21 | -0,22 | -0,17 | -0,14 |
| | om | 0,22 | -0,00 | -0,45 | -0,39 | -0,47 | -0,43 | -0,27 | -0,26 |
| | CEC | 0,13 | -0,04 | -0,57 | -0,27 | -0,36 | -0,30 | -0,20 | -0,21 |
| | carb | -0,20 | -0,03 | -0,59 | -0,30 | -0,26 | -0,23 | -0,21 | -0,00 |
| Pb | ff | -0,61 | -0,69* | -0,18 | -0,21 | -0,21 | -0,11 | -0,30 | 0,08 |
| | om | -0,65* | -0,70* | -0,34 | -0,61* | -0,62* | -0,40 | -0,06 | 0,20 |
| | CEC | -0,66* | -0,79* | -0,32 | -0,58 | -0,60* | -0,36 | -0,17 | 0,26 |
| | carb | -0,47 | -0,34 | -0,40 | -0,13 | -0,40 | -0,09 | -0,36 | 0,09 |
| Zn | ff | -0,51 | -0,81** | -0,69* | -0,65* | -0,31 | -0,37 | -0,64* | -0,24 |
| | om | -0,32 | -0,66* | -0,59 | -0,62* | -0,38 | -0,47 | -0,64* | -0,16 |
| | CEC | -0,33 | -0,71* | -0,76* | -0,63* | -0,35 | -0,49 | -0,58 | -0,10 |
| | carb | 0,09 | 0,18 | -0,04 | 0,34 | 0,19 | 0,29 | -0,18 | -0,12 |

(ff: fine fraction: % of sediment particles < 63 μm; om: % of organic matter; CEC: cation exchange capacity (meq/100g); carb: % of carbonates; n: number of samples; significance levels: * P < 0.05, ** P < 0.01, *** P < 0.001).

Table III; Results of the multiple regression analysis by the “stepwise” method. Only equations with at least two independent variables are shown.

Posidonia oceanica (n = 10)

roots: $\log[\text{Hg}] = 1,346864 + 0,401901 \times \log[\text{Hg}]_{\text{Sed}} - 0,438516 \times \log(\% \text{ o.m.})$
 $R^2 = 0,78^{**}$; contribution to $R^2 = \log[\text{Hg}]_{\text{Sed}}: 0,44$; $\log(\% \text{ o.m.}): 0,34$

leaves: $\log[\text{Hg}] = 1,029973 + 0,592843 \times \log[\text{Hg}]_{\text{Sed}} - 0,506527 \times \log(\% \text{ o.m.})$
 $R^2 = 0,89^{***}$; contribution to $R^2 = \log[\text{Hg}]_{\text{Sed}}: 0,63$; $\log(\% \text{ o.m.}): 0,26$

Caulerpa prolifera (n = 10)

fronds: $\log[\text{Hg}] = 3,340808 + 0,425032 \times \log[\text{Hg}]_{\text{Sed}} - 1,541604 \times \log(\% \text{ carb.})$
 $R^2 = 0,93^{***}$; contribution to $R^2 = \log[\text{Hg}]_{\text{Sed}}: 0,78$; $\log(\% \text{ carb.}): 0,15$

*Dependent variable: log[metal concentration] in the plant fraction, in ng/g for Hg and µg/g for Cd, Pb and Zn. Independent variables: log [metal concentration] in the sediment; log(% fraction < 63 µm); log(% organic matter) (o.m.); log (CEC), in meq/100g; and log(% carbonates) (carb.); n = number of samples; R2 = determination coefficient; contribution to R2 = increase in R2 when a new independent variable enters in the equation; significance levels: * P < 0.05, ** P < 0.01, *** P < 0.001).*

Bioaccumulation of heavy metals and radionuclides in the *Posidonia oceanica* meadow, an endemic Mediterranean ecosystem

Michel Warnau

International Atomic Energy Agency, Marine Environment Laboratory, Monaco

The infralittoral part of the Mediterranean coastal zone is mainly covered by one ecosystem, the *Posidonia oceanica* meadow, framed by a marine phanerogam (*Posidonia oceanica*) endemic to the region. This highly productive ecosystem with enriched biodiversity is considered by some as the “climax” community on Mediterranean soft bottoms (Ott, 1980; Pergent *et al.*, 1994). It covers about 40.000 km² of the sea floor (i.e. 1 to 2% of the total surface of the Mediterranean) and plays crucial roles in the marine ecology of the Mediterranean. Indeed, the meadows (1) are responsible for 5 to 10% of the primary production of the whole sea of which a substantial part (up to 80%) is exported off the meadows, (2) produce high amount of O₂, (3) are spawning, nursery or permanent habitat for a wide diversity of animal and plant species, and (4), play a key role in the stabilisation of soft bottoms and protection of shores.

However, due to their bathymetric distribution (from surface to ca. 40 m depth), seagrass meadows are directly exposed to coastal human activities (e.g., Shepherd *et al.*, 1989). Over the last decades several meadows have been regressing dramatically, particularly those situated near important urban or industrial areas (Pergent *et al.*, 1995). Consequently, *P. oceanica* meadows are considered as a threatened habitat (UNEP/FAO/WHO 1996) and are included in the EC Habitats Directive as a priority habitat. Several factors are thought to contribute to this decline: increase in turbidity or in sedimentation, trawling activities, and moorings, coastal discharges of various xenobiotics (e.g., detergents, oils, heavy metals, radionuclides), and perhaps recent competitive pressure from the introduced tropical alga *Caulerpa taxifolia*.

Although virtually no data are available about the effects of metals on the Mediterranean *P. oceanica* meadows, it was demonstrated that these pollutants do affect similar ecosystems. Indeed, the impacts of contamination by Cd, Pb and Zn originating from a smelting plant are well documented on *P. australis* meadows (Ward, 1989 and references therein). Among others, metals were shown to strongly affect biodiversity and abundance of crustaceans and fish in the exposed meadows. These data, together with what we know about the special status of the Mediterranean as regards pollution, demonstrate that metal contamination in the *P. oceanica* meadow is actually a major matter of concern. This is now a widely adopted point of view among “Mediterranean” marine ecotoxicologists. Consequently numerous investigations have been conducted in the *P. oceanica* meadows during the past 20 years. In addition, there is also a kind of general agreement that has led most scientists to approach the problem through the study of contaminant bioaccumulation and, more specifically, through the use of bioindicator species.

Usual pollution bioindicators (i.e. bivalves) are generally not present in the *Posidonia* meadows and other taxa have to be used. Surprisingly, only two species have been investigated in a manner that is sufficient to indicate that they qualify as valuable bioindicators: the seagrass *P. oceanica* and the sea urchin *Paracentrotus lividus*, one of the main consumers of the seagrass leaves.

Experimental studies on metal bioaccumulation in these species were most generally carried out using radiotracer techniques (Guary 1980; Miramand *et al.*, 1982; Warnau *et al.*, 1995, 1996a,b, 1997). Uptake and loss kinetics are known for a few metals and radionuclides (Cd, Zn, Co, Ag, V, Cs, Am in *P. oceanica* exposed via sea water; Cd, Zn, Co, Ag, V, Cs, Am, Pu, Np in *P. lividus* exposed via sea water or via the food). Beside knowledge of some important kinetics parameters (biological half-lives of incorporated metals, assimilation efficiency of ingested metals), these studies also showed that the considered elements were generally efficiently taken up and retained in the tissues of both species and indicated that both the seagrass and the sea urchin were able to integrate over time the contamination history of their environment. For *P. lividus*, it has also been shown that there is a proportional relationship between Cd taken up by the sea urchin and Cd concentration in the surrounding sea water.

Field studies are more numerous than experimental ones, and they have provided a series of data about *P. oceanica* and *P. lividus* contamination by heavy metals and radionuclides in a wide variety of locations (although mainly from the NW part of the Mediterranean) (e.g., Papadopoulou *et al.*, 1976; Malea and Haritonidis, 1989; Catsiki *et al.*, 1991; Maserti *et al.*, 1988; Warnau *et al.*, 1998; Sanchez-Cabeza and Molero, 2000; Campanella *et al.*, 2001; Sanchiz *et al.*, 2001). These field surveys have allowed not only characterizing more or less extensively the contamination status of various meadows, but constitute also a substantial database that allows to pinpoint a series of factors that have to be taken into account in order to interpret correctly the bioindicative information gathered through the seagrass or the sea urchin. These factors are for instance body compartment to focus on, natural fluctuations of metal contents due to sexual or metabolic cycle, or natural variations of metal content due to age/size of the organisms. Some studies have investigated both species simultaneously; the general concordance among information gathered from each of them strongly suggested the organisms' validity to qualify as bioindicator species.

One of the most interesting findings is the capacity of the plant to preserve to some extent the information concerning a contamination event over the long term. Indeed, lepidochronology allows dating the scales (viz. the leaf sheaths that persist after the leaf blades have been shed) along the rhizome of *P. oceanica* (Boudouresque *et al.*, 1983). This "memorization" property appears to be an interesting tool and has been frequently used to trace the history of metal and radionuclide contamination (e.g., Carlotti *et al.*, 1992; Roméo *et al.*, 1995). Good correlations between lepidochronology and records of environmental discharges have been observed for Hg (Pergent-Martini, 1998) and radionuclides originating from nuclear atmospheric tests and the Chernobyl accident (Calmet *et al.*, 1988, 1991; Carlotti *et al.*, 1992).

Several studies have shown that other organisms (e.g., algae, crustaceans, molluscs) from *P. oceanica* meadows also concentrate heavy metals (e.g., Catsiki *et al.*, 1991; Sanchez-Cabeza and Molero, 2000; Campanella *et al.*, 2001; Sanchiz *et al.*, 2001). Although these investigations are always limited to series of concentration measurements, the selected organisms are often automatically considered (and used) as bioindicator species, without taking into account any of the prerequisites which should be met for an organism to be considered as a useful bioindicator (Phillips, 1980).

Nevertheless, all these studies provide useful data sets that allow describing the present contamination status of various locations and contribute to the global knowledge of the Mediterranean meadows. However, before these data can be used on a larger scale (e.g. in a "Meadows Watch") and in a predictive way, they will require comparability. And this will become possible only after a better uniformity is achieved among methodologies used by the different scientific teams involved in these research efforts. This standardization concerns methods used to collect, prepare and analyze samples (for instance some authors still rinse marine samples with de-ion-

ized water; see recommendations by Ledent *et al.*, 1995). But, more important, instead of investigating at a single point in time a wide range of organisms mainly because of their local availability, efforts should be focused on sampling systematically a limited number of species that are well characterized from the bioindication point of view. This implies concerted work both in the laboratory and in the field to select, characterize and validate species to be used as bioindicators. The phanerogam *P. oceanica* and the sea urchin *P. lividus* are presently the best candidates (because most of available data concern these two species), but a few additional species would be most useful to complement the variety of information that can be gathered through a multi-species monitoring approach. This approach should begin by characterizing the bioaccumulation properties of the selected species, including establishing the relationship between environmental and tissue concentrations of the contaminant. Optimally, final validation of the potential bioindicators should be performed in situ along a contamination gradient in their natural environment (Temara *et al.*, 1998).

Acknowledgements. The IAEA-Marine Environment Laboratory operates under a bipartite agreement between the International Atomic Energy Agency and the Government of the Principality of Monaco.

Role of plankton in controlling fluxes and residence times of metals and radionuclides in the sea

Scott W. Fowler

International Atomic Energy Agency (IAEA), Marine Environment Laboratory (MEL), Monaco

The term “plankton” is applied to a group of relatively small animals and plants which live freely in the water column, have limited or no powers of locomotion, and thus are more or less passively carried in a given water mass. Nearly every major group of organisms are represented in the plankton and they range in size from microscopic submicron-size virus and bacteria to jellyfish several centimeters in diameter. Because of their ubiquitousness and vast number, together phytoplankton and zooplankton make up globally the largest fraction of the marine biomass and are therefore potentially important in the biogeochemical cycling of trace metals and radionuclides in the oceans.

Because plankton is comprised of so many different groups of organisms, it is beyond the scope of this review to examine, where information is available, metal and radionuclide bioaccumulation processes in each of the different species. Plankton are often treated as a non-homogenous community of organisms and most of the previous studies on plankton biogeochemistry have focused on plankton as a functional group or on the dominant species therein. Although the plankton may range in size over some 7 to 8 orders of magnitude, all the species are nevertheless relatively small (< few cms) which results in a high surface area to volume ratio for each entity. This general feature of having an enormous surface area in contact with sea water in many cases leads to enhanced surface adsorption of metals and radionuclides, and results in the very high levels and concentration factors of these elements observed in plankton (Lowman *et al.*, 1971; Fowler, 1977, 1990). It therefore follows that bioaccumulation and excretion processes in the plankton may have a profound effect on the fluxes and residence times of metals and radionuclides in many marine contaminants.

Trace element distributions in the sea strongly depend upon current and water mass movements, eddy diffusion and sedimentation processes. Movements of elements associated with plankton are also subject to physical and geological transport processes but, in addition, are affected by bioaccumulation, retention, and subsequent food chain transfer, horizontal and vertical migration, and passive sinking of biodebris formed by these organisms. Clearly, the relative importance of these biological transport mechanisms compared to physical and chemical processes is a function of the oceanic biomass at any given location. Various aspects of metal and radionuclide bioaccumulation, bioavailability, food chain transfer and metabolism in marine plankton have been the subject of in-depth reviews (Lowman *et al.*, 1971; Davies, 1978; Fowler, 1982; Fisher and Reinfelder, 1995).

This brief overview only attempts to highlight what we presently know and do not know about some of the more important biologically-mediated uptake, transfer and transport processes which

occur from the time metals and radionuclides enter and leave the surface layers of the water column until they ultimately reach depth. Emphasis is on geochemical implications of element redistribution by sinking biogenic particulates, a process which is currently receiving much attention in many oceanographic studies (Fowler and Knauer, 1986; Fisher and Fowler, 1987; Fisher *et al.*, 1988).

BIOACCUMULATION PROCESSES

For all plankton, metal and radionuclide uptake from water occurs by adsorption of the element onto the organisms' surfaces or absorption across body surfaces such as integument, gill and gut walls, or a combination of both. Phytoplankton, because of its large surface area to volume ratio, quickly takes up radionuclides and metals and reaches extremely high concentration factors (Table 1). The biphasic process involves rapid sorption to the cell surface, perhaps by cation exchange, followed by slower diffusion across the cell membrane and subsequent binding within the cell (Davies, 1978; Fisher *et al.*, 1983a; Fisher and Reinfelder, 1995). Equilibration times are generally short (minutes to hours) and there is some evidence in the case of Hg, Cd, Zn, and transuranic nuclides that uptake is a passive process (*ibid.*). Controlled laboratory experiments have shown that uptake of many metals depends on the metal concentration in sea water, the length of exposure, and the algal species.

Table 1. Selected trace element and radionuclide concentration factors (element/g wet animal divided by element/g water) for phytoplankton and crustacean zooplankton. Data taken from Fowler (1990) and IAEA (in press).

| Element/RN | Phytoplankton | Microzooplankton** | Macrozooplankton+ |
|-----------------------|---------------------------------------|--------------------|-------------------|
| *Hg | 1x10 ⁵ | 1x10 ⁴ | 4x10 ³ |
| *Ni | 8x10 ³ | 3x10 ³ | 6x10 ² |
| *Co | 2x10 ³ | 7x10 ³ | 6x10 ³ |
| *Cd | 1x10 ³ | 6x10 ⁴ | 2x10 ⁴ |
| *Cu | 1x10 ⁴ | 5x10 ⁴ | 1x10 ⁵ |
| *Fe | 4x10 ⁵ | 3x10 ⁵ | 2x10 ⁵ |
| *Zn | 1x10 ⁴ | 1x10 ⁵ | 1x10 ⁵ |
| Tc | 4x10 ⁰ | 1x10 ² | 1x10 ² |
| ²³⁹⁺²⁴⁰ Pu | 9x10 ⁴ – 1x10 ⁵ | 4x10 ³ | 1x10 ² |
| ²⁴¹ Am | 2x10 ⁴ – 1x10 ⁵ | 4x10 ³ | 1x10 ³ |
| ¹⁴⁴ Ce | 9x10 ⁴ | 6x10 ³ | - |
| ¹⁰⁶ Ru | 2x10 ⁵ | 3x10 ⁴ | - |
| ²³⁸ U | 2x10 ¹ | 3x10 ¹ | - |
| ²³² Th | 2x10 ⁴ | 2x10 ⁴ | - |
| ²³⁰ Th | 8x10 ³ | 4x10 ³ | - |
| ²²⁸ Th | 2x10 ⁴ | 6x10 ³ | - |
| ²²⁶ Ra | 2x10 ³ | 1x10 ² | - |
| ²¹⁰ Po | 7x10 ⁴ | 3x10 ⁴ | 1x10 ⁴ |

* Computed using recent values for trace element concentration in sea water

+ Euphausiids

**Mainly copepods

Heterotrophic zooplankton also absorb elements directly from sea water but, in addition, accumulate them through assimilation of ingested food (Fowler, 1982; Wang *et al.*, 1996b). Direct uptake from sea water occurs both by adsorption onto body surfaces and absorption of the elements across surfaces, such as gills or gut wall. Once across the cellular boundaries the elements are translocated to other organs and tissues by either active or passive processes where they are stored or eventually eliminated. Uptake rates strongly depend on the element, with reported equilibration times ranging from several hours to several days (Fowler, 1982 for review; Wang and Fisher, 1998). Element concentrations in marine plankton are in a state of dynamic equilibrium and are the net result of both uptake and elimination processes occurring simultaneously. These dynamic processes are controlled by exposure time, the physicochemical form of the element, salinity, temperature, competitive effects with other substances, life cycle of the organism, physiology and feeding habits. Hence, concentration factors in zooplankton vary greatly (ranging over

several orders of magnitude) and may best be viewed in terms of ranges rather than absolute values (Table 1). In general, the highest concentration factors are noted for elements and radionuclides which are “particle reactive” in sea water, whereas low concentration factors are typical for the elements which behave more conservatively in sea water.

Amongst the plankton, smaller organisms generally attain higher concentration factors than larger species because of the former's greater relative surface area for adsorption. Furthermore, for certain particle-reactive radionuclides such as plutonium and americium, concentration factors are directly related to the surface to volume ratio of zooplankton and phytoplankton species (Fisher and Fowler, 1987). For these small planktonic organisms concentration factors on the order of 10^4 - 10^5 are not uncommon for several elements (Table 1). Unfortunately, because of difficulties in sampling, comparable data for the smaller bacterio-plankton do not exist; however, there is some evidence from laboratory experiments using ^{241}Am that marine bacteria may reach volume concentration factors in the range 10^6 - 10^7 (Fowler, 1990). Such high enrichment factors alone make small species potentially important in affecting subsequent element redistribution throughout the water column. Moreover, their rapid life cycles, migratory behaviour, physiology and feeding strategies further enhance their importance in the biological transport of elements in the sea. Despite the wide variety of different species in the zooplankton community, most of the experimental studies on bioaccumulation by plankton have been carried out with micro- or macro- crustaceans such as copepods (Fisher and Reinfelder, 1995) and euphausiids (Fowler, 1982).

TRANSFER AND CYCLING

Bioaccumulation is not the only process affecting the flux and cycling of elements by the planktonic community: food chain dynamics, excretion, molting and death are other key factors which result in the redistribution and cycling of metals and radionuclides. With respect to food chain transfer, many recent studies have been focused on the fractions of metals assimilated at each step of the plankton food chain (Fowler, 1982; Reinfelder and Fisher, 1991; Fisher and Reinfelder, 1995; Wang *et al.*, 1996b). Most evidence from both laboratory and field demonstrates that trace element and radionuclide concentrations in marine micro-organisms tend to decrease with each increasing step in the food chain. The only exception appears to be mercury; for example, mercury has been found to increase slightly in a specific microplankton-zooplankton-nekton food chain in the Mediterranean (Fowler, 1986). However, the question still remains whether in these small microheterotrophs mercury is obtained by absorption from water, or that some form of it like methyl mercury is actually biomagnified through the food chain.

Regardless of the mode of element bioaccumulation in plankton, the subsequent elimination of elements through excretion is important in maintaining elemental balance within the organism as well as affecting the marine biogeochemical cycles of many metals and radionuclides. Elimination occurs by passive desorption, active excretion of the soluble element, and particulate excretion via zooplankton feces, molts and reproductive products. Most often trace elements are lost from plankton more slowly than they are accumulated. Loss rates are rarely constant; hence, there are biological half-times characteristic of the various individual element pools within the organism. Biological half-times for element loss vary from several hours to a few days for phytoplankton and zooplankton species (Fowler, 1982; Fisher *et al.*, 1983a,b). As one example, earlier studies measured the soluble excretion of radionuclides from zooplankton which had been contaminated *in situ* by nuclear testing in the north Pacific (Keunzler, 1969a,b). Rapid loss rates of 1 to 22%/hr were noted for radioactive I, Zn, Co and Fe reflecting both the short exposure time and the fact that loss was only measured for a few hours. However, more recent evidence indicates that long-term depuration from zooplankton does not follow a single exponential rate but takes place from both fast and slowly exchanging compartments (Fowler, 1982 and refs. therein). Therefore, the rates measured for the naturally contaminated zooplankton probably reflect loss from a rapidly exchanging pool which may represent only a small fraction of the organisms' total pollutant load. Various biokinetic models which have been developed to assess the flux of metals and radionuclides through zooplankton depend heavily on soluble excretion rates to determine total excretion (Small *et al.*, 1973; Wang and Fisher, 1999b; Fisher *et al.*, 2000). Therefore, it is important that soluble loss from all labelled pools within the plankton are taken into account when deriving the soluble excretion parameter for such models.

Other factors that will affect element elimination are temperature and length of time that zooplankton are exposed to the metal or radionuclide. Furthermore, elimination rates will vary greatly with species; for example, at frequent intervals planktonic crustaceans lose a large fraction of their element body burden when they molt. Molting rates increase with temperature, therefore element elimination via molting is likely to be more important in the warmer, upper layers of the water column.

Often the most important excretion route in zooplankton is defecation. Especially for non-biologically essential elements or those which are poorly assimilated, excretion via feces becomes increasingly important. Element assimilation from food is therefore an important aspect of metal and radionuclide bioaccumulation in zooplankton and consequently, it is currently an active area of research in the field of trace element biogeochemistry (Fowler, 1982; Fisher *et al.*, 1991a; Reinfelder and Fisher, 1991; Wang *et al.*, 1996b; Anastasia *et al.*, 1998; Wang and Fisher, 1999a). Using accurate knowledge of assimilation rates and the varied parameters that control them, reasonable estimates can be deduced of the fractions of metals and radionuclides which will be released in fecal pellets for eventual cycling in or removal from the water column.

The production of zooplankton fecal pellets is therefore one of the key vectors controlling the vertical flux and resultant residence times of elements in the sea. Initial trace metal and radionuclide enrichment occurs on the smallest planktonic forms and, primarily through grazing activities of zooplankton, these small particles (e.g., phytoplankton cells) and organic aggregates are “packaged” into larger detrital particles which rapidly sediment due to their increased sinking speeds. Alternatively, plankton can transport incorporated elements through their horizontal and vertical movements. Phytoplankton migrate very little but many species of zooplankton undertake diel vertical migrations over several hundred meters. Nevertheless, model studies indicate that diel vertical migration is restricted to roughly the top 1000 meters for these species and conclude that sinking detrital products (e.g., fecal pellets, molts, shells, carcasses, phytodetritus, etc.) from the plankton are more important than vertical migration for the downward transport of elements (Lowman *et al.*, 1971; Small and Fowler, 1973).

Specialized field collection techniques have been used to sample zooplankton excreta for specific elemental analyses. The data indicate that biogenic detrital particles originating from zooplankton are extremely rich in many trace elements and radionuclides (Table 2). Furthermore, concentrations are often higher in these types of particulates than in the organisms producing them or their precursor prey (Fowler, 1977; Higgs *et al.*, 1977; Krishnaswami *et al.*, 1985).

Table 2. Environmental levels of trace elements and radionuclides in Mediterranean macrozooplankton, their particulate products and their natural mixed microplankton food (From Fowler, 1990).

| Element | Macroplankton | Fecal pellets ($\mu\text{g g}^{-1}$ dry) | Molts (%)** | Food (microplankton) |
|-------------------------|---------------|--|-------------|-------------------------|
| Ag | 0.7 | 2.1 | 2.9 (31) | 0.7 |
| Cd | 0.7 | 9.6 | 2.1 (22) | 2.1 |
| Co | 0.2 | 3.5 | 0.8 (34) | 0.9 |
| Cr | 0.9 | 38 | 5.3 (48) | 4.9 |
| Cu | 48 | 226 | 35 (6) | 39 |
| Fe | 64 | 24000 | 232 (28) | 570 |
| Mn | 4 | 243 | 12 (21) | 18 |
| Ni | 0.7 | 20 | 6.7 (78) | 8.1 |
| Pb | 1 | 34 | 22 (~100) | 11 |
| Zn | 62 | 950 | 146 (18) | 483 |
| Hg | 0.3 | 0.4 | 0.2 (4) | 0.1 |
| Se | 4 | 7 | 2 (3) | 3 |
| $^{239+240}\text{Pu}^*$ | 0.4 | 98 | 4.8 (90) | 4.0 |
| $^{210}\text{Po}^*$ | 1100 | 24500 | 360 (2.5) | 3400 |
| $^{232}\text{Th}^*$ | 0.35 | 250 | 2.6 (57) | 17 |
| $^{238}\text{U}^*$ | 21 | 520 | 245 (90) | 340 |

* pCi/kg dry . $1 \text{ pCi} = 37 \text{ kBq}$

** Percent of total body burden contained in molt.

Element enrichment in pellets occurs when organic rich food particles are ingested and subsequently stripped of nutritive material (loss of dry weight) with the resultant residual fecal pellet, composed mainly of non-digestible hard parts, displaying further trace metal or radionuclide enrichment. Since the bulk of biogenic debris like fecal pellets is produced in the surface layers, it is not surprising that these particles are primary vectors for removing trace elements from the upper water column. Furthermore, fecal pellets may continue to scavenge elements and radionuclides as they sink through the water column (Fisher *et al.*, 1991c). In fact, using elemental concentrations in biogenic particles and mass balance considerations of river input and sediment output of the same elements, model studies have concluded that the settling of fecal pellets and fecal aggregates is the most important mechanism effecting the vertical transport, and thus residence time, of many trace elements (Cherry *et al.*, 1978; Li, 1981). However, the data used for these models like those presented in Table 2 are extremely limited and far more information on trace elements and radionuclides in a variety of fecal pellets and other biogenic detrital particles are needed in order to confirm the relative importance of zooplankton feces in controlling trace element residence times. For such small samples, a multi-element analytical approach is ideal in order to understand the concentrations and relative behaviours of different elements (e.g., elemental ratios) in a single matrix. In particular, such techniques as energy dispersive XRF, micro-PIXE and laser ablation ICP-mass spectrometry could be instrumental in determining the micro-distribution of elements in particles produced by zooplankton as well in zooplankton tissues which are normally too small to dissect (e.g., Price and Pearce, 1997; Mages *et al.*, 2001; Twining *et al.*, 2001).

Testing trace element transport hypothesis in the field is difficult; however, the use of sediment traps has allowed directly examining certain aspects of the processes by which plankton accumulate metals and radionuclides, repackage them and transport them to depth (Fowler *et al.*, 1983, 1987, 1991; Fowler and Knauer, 1986; Fisher *et al.*, 1988). One good example in the western Mediterranean was the flux data from high resolution, time-series sediment traps which clearly demonstrated that Chernobyl fission products arriving at the sea surface essentially as a single pulse on 3 May 1986, were rapidly transported to 200 m in approximately 7 days primarily by zooplankton grazing activities (Table 3). Microscopic examination of the trap samples containing the bulk of the radioactivity indicated they were composed mainly of copepod fecal pellets. Fresh pellets collected from copepods living above the traps were found to contain similar radionuclide concentrations and ratios as those in the trap material, confirming that such pellets were responsible for transporting the surfaced-introduced radioactivity to depth. Furthermore, isotopic ratios in pellets, air, water and copepods indicated that particle reactive radionuclides like ^{144}Ce , ^{141}Ce , ^{106}Ru , ^{103}Ru were scavenged to a far greater extent by sinking fecal pellets

Table 3. Prominent Chernobyl fallout radionuclides in large particles (Bq g^{-1} dry) collected at 200 m depth in a 2200 m water column 15 miles off Calvi, Corsica (Samples 1-6) and in fecal pellets produced by zooplankton living over the traps (Sample 7). After Fowler *et al.* (1987).

| Sample | 1 | 2 | 3 | 4 | 5 | 6 | 7 |
|-------------------|-------------|-------------|--------------------|-----------|----------|-----------|--------------------|
| Date: | 13-20 April | 20-26 April | 26 Apr. – 2 May | 2-8 May | 8-15 May | 15-21 May | 6 May (pellets) |
| Dry wt. (mg) | 167.8 | 87.5 | 50.17 | 51.43 | 42.06 | 45.26 | 42.5 |
| Radionuclide | | | | | | | |
| ^{95}Zr | <0.07 | <0.2 | <0.3 | <0.2 | 24.5±1.4 | <0.2 | 1.4±0.8 |
| ^{95}Nb | <0.03 | <0.1 | <0.2 | <0.1 | 31.8±1.1 | <0.2 | <0.2 |
| ^{103}Ru | <0.06 | <0.1 | <0.2 | 3.7±0.2 | 23.6±1.0 | 14.0±0.4 | 16.0±1.9 |
| ^{106}Ru | <0.2 | <0.4 | <0.8 | 1.1±0.5 | 5.4±1.8 | 3.5±0.7 | 5.8±2.9 |
| ^{134}Cs | <0.05 | <0.05 | <0.05 | 0.41±0.05 | 2.1±0.2 | 1.9±0.1 | 3.4±0.6 |
| ^{137}Cs | <0.05 | <0.05 | 0.15±0.08 | 0.85±0.08 | 3.8±0.3 | 4.0±0.1 | 6.3±1.0 |
| ^{141}Ce | <0.2 | <0.2 | <0.3 | 1.3±0.7 | 12.6±0.6 | 1.1±0.5 | 0.9±0.4 |
| ^{144}Ce | <0.06 | <0.3 | <0.3 | <0.2 | 13.6±0.7 | <0.4 | 2.5±1.3 |

Trap values are decay-corrected for midpoint of sampling period. Values preceded by < indicate limits of detection.

than the cesium nuclides, an observation consistent with the radionuclides' chemical behaviour in sea water.

Thus, direct measurements of particles from sediment traps deployed under various, and sometimes fortuitous, conditions have confirmed the importance of plankton debris in rapidly transporting metals and radionuclides from the euphotic zone to depth. The larger question remains regarding the ultimate fate of these trace element-enriched, biogenic particles, and several studies have been undertaken to examine the trace element remineralization processes and rates associated with sinking particles (Fowler and Knauer, 1986; Fisher and Fowler, 1987; Fisher *et al.*, 1988, 1991b,c; Lee and Fisher, 1992a,b, 1994; Fisher and Wentz, 1993; Reinfelder *et al.*, 1993). Information to date suggests that, in general, metabolically essential metals and radionuclides that are often bound to sulphhydryl group and other proteins are remineralized more rapidly than non-essential, particle-reactive elements which are often associated with surfaces of non-labile materials in these particles. Many of these data are derived from laboratory radiotracer studies and it would be a step forward if a method could be devised to test these hypotheses and ground-truth such experimentally determined remineralization and scavenging rates in nature.

CONCLUSIONS

Bioaccumulation processes result in a high enrichment of metals and radionuclides in plankton primarily because of the large relative surface area for adsorption in the different species comprising the plankton community. In terms of trace element and radionuclide concentration data, most information pertains to zooplankton with lesser amounts available for phytoplankton, and virtually no information about levels in bacterio-plankton because of the difficulty in obtaining pure samples in sufficient quantity for analysis. Concerning zooplankton, present information on bioaccumulation potential and the biokinetics involved is largely derived from crustaceans (i.e. copepods and euphausiids) which, while often the dominant forms in the community, are not the only common zooplankton species. Many other crustaceans (amphipods, isopods, mysids, ostracods, larval decapods, etc.) as well as molluscan species (pteropods and heteropods) are sometimes abundant. Soft-bodied or gelatinous forms such as chaetognaths, polychaetes, salps, medusae and larvaceans are other important members for which comparable information is largely lacking. Moreover, what little we do know from some initial studies indicates that metal and radionuclide bioaccumulation and retention processes and rates in soft-bodied forms may be quite different from those typical of planktonic crustaceans (Gorsky *et al.*, 1984; Krishnaswami *et al.*, 1985; Fisher and Fowler, 1987; Fisher *et al.*, 1991b). Clearly, some effort should be expended to obtain comparable data for these other important plankters.

Through heterotrophic processes, the smallest micro-organisms are ingested and aggregated into larger particles which also contain elevated concentrations of many elements and radionuclides. These larger aggregates sink more rapidly than the individual plankton species or suspended detrital particles which form them and, thus, act as rapid conveyors of these elements to depth. During descent biogenic particles may further adsorb and subsequently scavenge metals and radionuclides from the water column, or release them during remineralization at depth. Recent sediment trap studies have confirmed that large organic aggregates such as zooplankton fecal pellets are instrumental in removing trace metals and radionuclides from the euphotic zone and rapidly transporting them to depth, yet quantitative field data on element concentrations, scavenging rates, remineralization rates and vertical fluxes are still sparse.

What is now needed are properly-designed field experiments using time-series sediment traps in conjunction with real-time sampling of plankton and their freshly-produced particulate products at different depths in order to closely examine element transport and remineralization processes at higher resolution and in more detail. In this way, greater insight will be obtained about which metals and radionuclides are being scavenged and removed to depth, and which are being remineralized and retained in the water column. Furthermore, through time-series collections of the above-mentioned materials, additional information on the rates at which these processes are proceeding could also be obtained.

Finally, because plankton-derived particles are so important in understanding basic biogeochemical cycles of elements and radionuclides in the sea, some effort should be made to discern the loci of element enrichment and micro-distribution within the different types of biogenic par-

ticles. Dispersive XRF, PIXE microprobe and laser ablation ICP-MS analyses would appear to be particularly well-suited to elucidate elemental micro-distributions in both plankton and their detritus.

Acknowledgements. The IAEA Marine Environment Laboratory operates under an agreement between the International Atomic Energy Agency and the Government of the Principality of Monaco.

Models for the bioaccumulation of metals in aquatic organisms

Ronny Blust

Department of Biology, University of Antwerp, Belgium

INTRODUCTION

Aquatic organisms are exposed to trace metals and radionuclides via different routes including water, sediment and food. The uptake, accumulation and toxicity of these ions and molecules strongly depend on the exposure conditions and vary orders of magnitude within and among species. These differences can be explained by the effects of physical, chemical and biological factors on the uptake, accumulation and toxicity of the metals (Newman and McIntosh, 1991; Tessier and Turner, 1995; Newman *et al.*, 2001). A complete understanding of the effects of metals exposure on aquatic organisms and ecosystems requires the functional coupling of the different processes that occur under specific conditions in a dynamic manner. To realise this models can be constructed that link the different processes to each other. As such models are a powerful tool to analyse these complex events and predict the combined result of the different processes in a space and time resolved manner (Barron *et al.*, 1990; Wang *et al.*, 1996a; Blust, 2001).

Different types of dynamic models can be constructed ranging from very simple one compartmental models to highly complex multi-compartmental models. One compartmental models consider the organism as a single homogeneous pool with an input (uptake) and an output (elimination). More complex models incorporate more compartments so that the metal uptake and internal compartmentalisation is described with more detail and realism. However, the more complex a model becomes, the more information is required to parameterise the model. This requires long term and detailed experiments to follow and in many cases that information is not available or difficult to obtain experimentally. Therefore it is important to carefully consider the purpose of the models and decide on that basis what kind of sophistication and resolution is required to answer the questions being addressed. Examples of some simple compartmental models are presented in Figure 1.

MODELLING METAL ACCUMULATION

To model metal accumulation and toxicity different aspects have to be considered. The first important consideration relates to exposure. Metal uptake strongly depends on the environmental chemistry and compartmentalisation of the metals in the environment. Metals are distributed among different phases including dissolved, suspended and sediment fractions (Morel, 1983; Honeyman and Santschi, 1988; Ure and Davidson, 1995). Within each fraction the metals exist in various forms (species) of which the availability for uptake by aquatic organisms may be very different. In addition organisms take in metals via food and the concentration of the metal in the

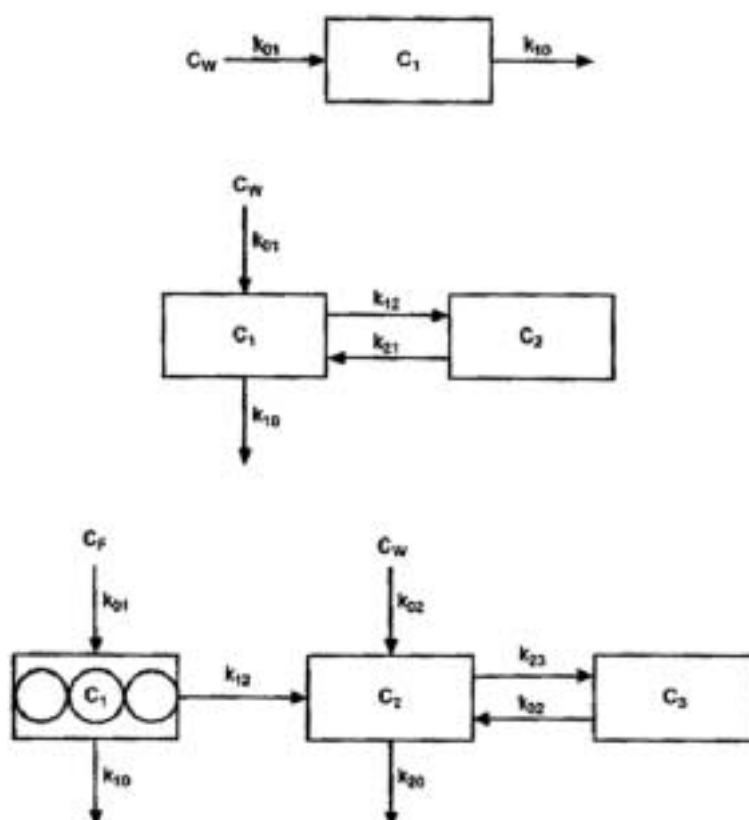

Fig. 1. One, two and three compartmental models.

food will be determined by the way in which the food items are exposed to the metals. A more or less realistic metal accumulation model accounts for these different exposure routes by including uptake via water (e.g. gills) and food, sediment or particulate matter (e.g. gut). The rate of metal uptake is expressed in terms of uptake rate constants and/or assimilation efficiencies. Combining this information with data on the concentration of the metal in the water and the ingestion rates of particles and food makes it possible to determine the relative importance of the different exposure phases for metal uptake (Fisher *et al.*, 1996; Hare *et al.*, 2001; Chang and Reinfelder, 2002).

Metal uptake also strongly depends on the chemical speciation of the metals in the different exposure phases. Very often a direct relationship between metal exposure concentrations and metal uptake does not exist because the fraction of the metal present in the exposure phase that is available for uptake is not related to the metal total concentration. Thus, to model metal uptake in a realistic manner, the chemical speciation of the metal in the exposure phases also has to be taken into account. In a metal accumulation model this is done by relating metal uptake to the fraction of the metal that is available for uptake, instead of the total concentration. For metal uptake via water it has been demonstrated that it is usually only the free metal ion that is available for uptake, although important exceptions exist, and that other metal species are much less – not or at all – available for uptake (Zamuda and Sunda, 1982; Rainbow *et al.*, 1993; Vercauteren and Blust, 1996).

Different analytical methods and models have been developed that can be used to determine the free metal ion activity (or concentration) and other species in complexing environments (Waite, 1989; Miller and Bruland, 1997; Twiss and Moffett, 2002). Also the uptake of metals across the gut strongly depends on its chemical speciation. How much of the metal is absorbed across the gut mainly depends on the availability of the metal in the digested material, the rate of metal transport across the gut epithelium and the gut residence time. In the model this translates into a metal and exposure phase specific assimilation efficiency. The gut is a very complex envi-

ronment with a chemistry that is completely different from the external environment. Metal uptake via the gut appears to involve different types of transporters and mechanisms that facilitate the uptake of different metal species. In addition gut chemistry also varies strongly among species so that very different assimilation efficiencies can be expected for different types of organisms (Reinfelder *et al.*, 1997; Wang, 2001; Schlekat *et al.*, 2002).

Metal uptake involves the binding of the free metal ion and possibly other species to specific transporters. The binding of a metal to a transporter depends on the exposure conditions. Differences in exposure conditions such as the hydrogen ion concentration, water hardness or the presence of other metal ions can strongly influence the binding of the metals to the transporters so that the direct relationship between the free metal ion activity and metal uptake across the biological interphase is lost (Campbell, 1995; Simkiss and Taylor, 1995; Chowdhury and Blust, 2001; Jansen *et al.*, 2002). These competitive and non-competitive interactions can be well described by existing transport models (i.e. Michaelis-Menten type models). Thus, the values of the metal uptake rate constants that are included in the accumulation models are actually rather variable and depend on the exposure situation. Nonetheless, these effects can be accounted for by incorporating the appropriate metal membrane transport (sub)model in the metal accumulation model as illustrated in Figure 2.

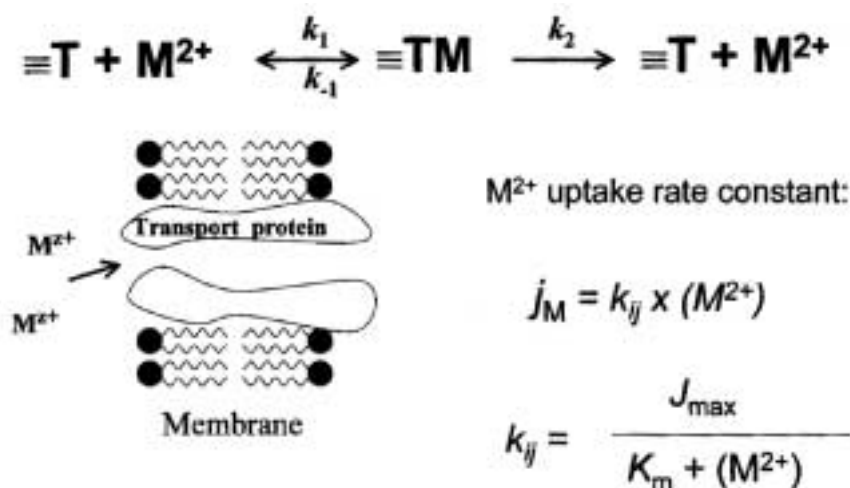

Fig. 2. Kinetic metal uptake model.

Inside an organism a metal is distributed among different compartments and tissues. Some of these tissues accumulate the metals to a large extent while others do not accumulate metals very intensively. Thus, inside an organism metals occur in different kinetic pools. To describe the kinetics of the metal accumulation process on a whole body basis level, it is generally not required to incorporate all these different (physiological) compartments. In many cases a two compartmental model or sometimes even a one compartmental model suffices to describe the uptake and elimination of the metal accurately. Parameterisation of the models requires that the uptake and elimination rate constants that describe the movement of the metals within and in and out of the organism are obtained by fitting the model to experimentally obtained information. Again it is important to note that the parameter values driving the model are not constants but variables that depend on the exposure conditions and the physiology of the organism (Wright, 1995; Rainbow, 1997a; Blust, 2001).

AN EXAMPLE: THE BIOENERGETIC-BASED ACCUMULATION MODEL

A frequently applied bioaccumulation model is the one proposed by Thomann (1981) incorporating toxicant uptake from both aqueous and dietary phases, in which the uptake rate is predicted in terms of the physiological energetics of the animals. With such a bioenergetics-based kinetic model, the bioaccumulation of metals in aquatic organisms can be studied in a mechanistic way. In the bioenergetic-based kinetic model, there are several parameters that control metal

accumulation from both the aqueous and dietary phases, including metal assimilation efficiency (AE) from the dietary phase, metal influx rate from the aqueous phase (or metal absorption efficiency from the dissolved phase), and metal efflux rate constants. Physiological parameters such as the ingestion rate of the animals, the growth rate constant, and geochemical parameters such as the metal concentration in the dissolved and particulate phases are also required. According to the first-order bioenergetic-based kinetic model bioaccumulation can be described by relatively simple mathematical equations (Thomann, 1981; Wang *et al.*, 1996a; Reinfelder *et al.*, 1998):

$$dC/dt = (k_u \times C_w) + (AE \times IR \times C_{n-1}) - (k_e + g) \times C \quad (1)$$

where C is the metal concentration in the animals at time t ($\mu\text{g g}^{-1}$), k_u is the uptake rate constant from the dissolved phase ($\text{L g}^{-1} \text{d}^{-1}$), C_w is the metal concentration in the dissolved phase ($\mu\text{g L}^{-1}$), AE is the metal assimilation efficiency from the ingested particles, IR is the ingestion rate of the animal ($\text{mg g}^{-1} \text{d}^{-1}$), C_f is the metal concentration in the ingested particles ($\mu\text{g mg}^{-1}$), k_e is the efflux rate constant (d^{-1}), and g is the growth rate constant.

With the assumption that there are no interactions between exposure pathways (i.e. additive uptake), the metal concentration in an organism under steady-state conditions resulting from accumulation from lower trophic levels ($C_{n,ss}$, $\mu\text{g g}^{-1}$) can be calculated as:

$$C_{n,ss} = \frac{(AE \times IR \times C_{n-1})}{(k_e + g)} \quad (2)$$

Thus, the food chain transfer factor (TTF) is:

$$\text{TTF} = C_{n,ss} / C_{n-1} = (AE \times IR) / (k_e + g) \quad (3)$$

AE x IR is the uptake rate constant from the dietary phase. TTF is analogous to the bioconcentration factor (BCF) that is frequently used to describe the extent to which a metal can be concentrated by an organism from ambient dissolved seawater. With such a simple mathematical model, the trophic interaction of a metal can be quantified by three parameters: AE, IR, and k_e . It is also possible to quantitatively separate the two exposure pathways (aqueous and dietary uptake) by comparing the influx of metals from each source:

$$R = (AE \times IR \times C_{n-1}) / [(k_u \times C_w) + (AE \times IR \times C_{n-1})] \quad (4)$$

Metal accumulation models only provide information concerning the kinetics of the uptake and elimination process and allow to predict steady state metal body or tissue concentrations for a given exposure situation. They do not provide information concerning the toxic effects that may or may not be related to the accumulation of the metals in the tissues. For this a more complex type of model is required that couples metal accumulation to metal toxicity. Such a model actually consists of two models superimposed on each other (toxicodynamic model is a coupled accumulation and effects model). Metal toxicity is either expressed in terms of metal exposure concentrations or metal tissue concentrations. The latter approach assumes that there is a so called critical whole body (or organ specific) concentration above which metal toxicity occurs. However, experimental studies have shown that this concept is not generally valid and that metal toxicity may occur over a wide range of body or organ concentrations (Borgmann *et al.*, 1991; Rainbow, 1997a; Mouneyrac *et al.*, 2002). An alternative approach may be to express toxicity in terms of metal uptake, accumulation or turnover rate. In addition, it appears that for the same metal tissue concentration the effects of waterborne or dietborne metal can be rather different. This appears to depend on differences in metal accumulation kinetics and internal compartmentalisation between the different exposure routes. In principle these effects can be accounted for in a toxicodynamic model but the information required to do this is currently lacking. What is required is detailed information concerning differences in metal accumulation, compartmentalisation and toxicity of metals when organisms are exposed via different exposure routes. Within this framework it is also important to consider the intracellular compartmentalisation of the metals and determine the bioactive metal fraction. Although this remains to be demonstrated, it is possible that a more consistent picture emerges when metal toxicity is expressed on a scale that takes into consideration the cellular speciation of the metals rather than the total concentration.

Processes affecting trophic transfer and resultant effects of metals : implications for monitoring metal pollution in the sea

Samuel N. Luoma

US Geological Survey, Menlo Park, CA 94025, USA

Adverse implications of metal contamination in marine environments are determined by what degree of contamination results in adverse effects. Yet the link between metal exposure and metal effects in marine organisms remains poorly known. Toxicity tests using different experimental protocols can vary widely, particularly when dietary exposure is considered (Hook and Fisher, 2001). One critical question is how external (geochemical) and internal (biological) influences determine metal exposure and bioavailability. Another is how internal processing by both prey and predator, as well as differing detoxification capabilities among species, contribute to variability in effects at a given exposure (Fig. 1). These processes are either unaccounted for or can differ among studies, and affect the ability to draw generalizations about what organisms are affected and at what exposures. Ultimately, such uncertainties affect how we monitor and evaluate effects of metals and radionuclides in systems such as the Mediterranean Sea.

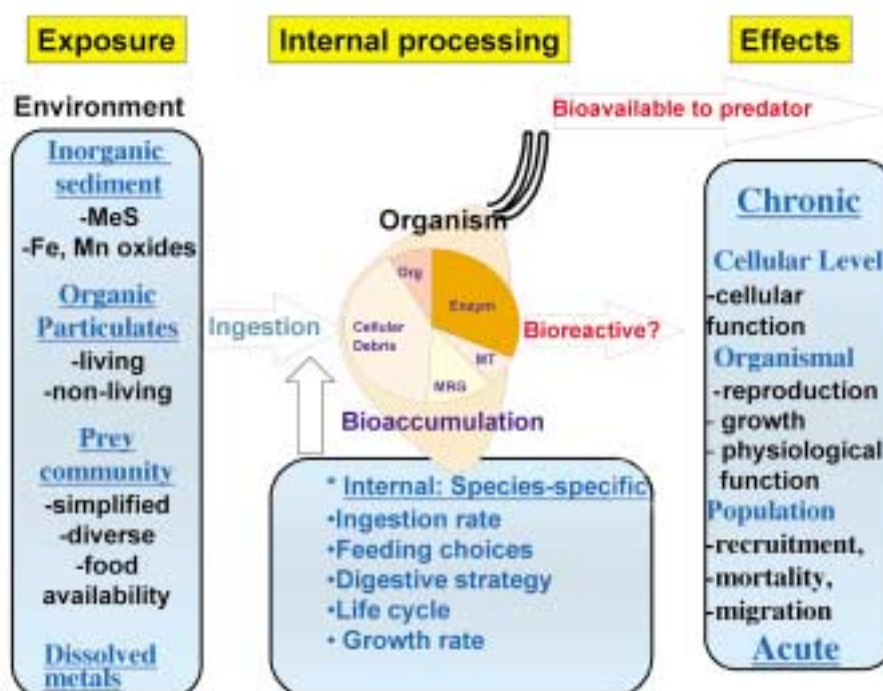

Fig. 1.

In terms of external factors, a number of studies have helped advance our understanding of how metal speciation affects bioavailability. But less is known when trophic transfer and metal bioavailability from diet are added to the equation. For example, equilibration time with sediments affects metal distribution between sediment particles and pore waters (K_d) dramatically, and thereby affects both toxicity and predominant exposure route. Figure 2 shows that shorter equilibration time results in lower K_d 's (more metal in pore water compared to particulate material) and more uptake from pore water compared to diet. Field studies and monitoring programs typically most commonly observe K_d 's from the right side of the figure. Monitoring designs using transplanted organisms must allow for high K_d 's and dietary exposure.

Zn in *P. amurensis* from dissolved phase vs. K_d

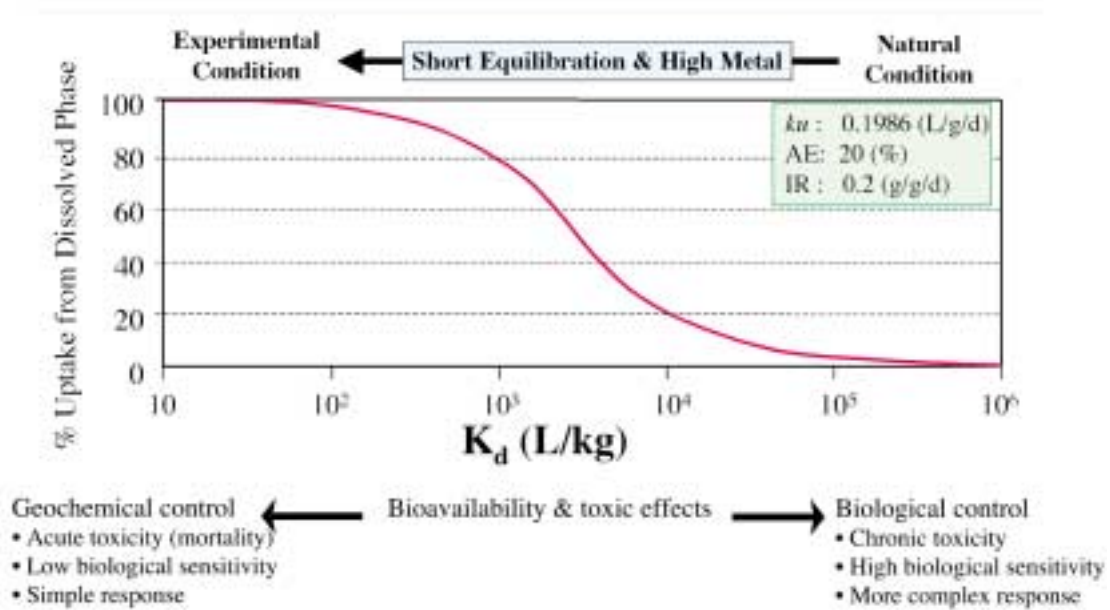

Fig. 2

It is well known that geochemical processes (e.g. redox conditions; distribution among types of binding sites) determine the form of metal in sediments; and that this affects bioavailability from particulate material, sometimes greatly (Luoma and Jenne, 1977; Di Toro *et al.*, 1991; Griscom *et al.*, 2001). Biologically, the distribution of metal among cytosol, detoxified forms and tissues or organelles in living prey, determine what form of metal a predator ingests, and thus metal bioavailability to the predator (Wallace and Lopez, 1996). Ecological processes that determine community structure also determine what prey or primary producers are available for ingestion.

Factors internal to the species are less discussed but also influence bioavailability. Feeding behavior differs widely among species (Fig. 1), and what an organism eats can greatly influence the concentrations of metal it ingests. Species create or live in very different micro-environments which determine the metal concentration, partitioning and form the organism experiences. Digestive processing is another internal factor that can affect assimilation from food (Decho and Luoma, 1996).

Animals not only select and digest their food differently, but also differ in the way they partition metals among internal biochemical fractions of their tissues. Because organisms evolved in an environment that contained metals, sophisticated detoxification processes have developed of course; all such process can be overwhelmed by elevated exposures. Detoxified metal forms occur as conjugates (e.g in granules within tissues) or associated with metal-specific protein systems specifically evolved to partition metals away from sites where they can cause damage (metallothioniens). Granules and metal-specific proteins can be operationally quantified (Wallace and Lopez, 1996). Similarly metal associated with cytosol or organelles can also be quantified oper-

ationally. A logical assumption is that such metal forms are likely to be available to active sites where damage can occur. Ultimately, operational schemes of defining internal metal form may be important parts of monitoring programs that define both exposure and effects of toxicants. Internal metal form not only influences the dose of metal that affects an organism, but it determines how much metal will be passed further up the food web (bioavailability to the next trophic level). Again monitoring internal metal form might allow generalizations about these important processes.

Despite these complexities some interesting generalizations about linkages between metal exposure and effects are appearing from both the field and laboratory. A few include:

1. In the field, exposure, bioavailability, bioaccumulation and effects are linked in a general sense (for example, bioaccumulation can presage effects in a single species/single environment situation – Hornberger *et al.*, 1999), but linear correlations across complex biological, geochemical or environmental gradients are probably the exception. For many metals, there may not be one tissue concentration that predicts effects across many species. But monitoring tissue concentrations of metal at a single site with a single species can be effective in relating exposure and effect.
2. Some species are likely to be much more vulnerable to metals or metalloids than others, based upon the internal and external differences described above. It could be argued that the ultimate goal in defining environmental effects of metals is to identify which species are most vulnerable to which metal/loids (perhaps, in which circumstances, although that may be least important). Ultimately monitoring programs might focus on such species. Empirical (field) and inferential (experimental) approaches in combination could yield generalizations about vulnerable species in a reasonable time frame. Yet this has not been a focus of many studies. If ecological effects are defined by the progressive disappearance of species of differing sensitivity, then understanding not only the biochemical, but also the geochemical, biological and ecological basis of that sensitivity can be the key to defining what species will disappear, when, and in what progression. Defining effects with broad ecological indices (number of taxa at a site), or with lab-derived definitions of toxicity to “biota” in generic terms are unlikely to result in any further clarity about metal effects than exists at present. But monitoring even presence/absence of previously defined vulnerable species, accompanied by monitoring metal exposure might provide insights about effects beyond what exists today.
3. Large differences in bioaccumulated metal/lloid among animal species are common in nature, and may provide clues to which species are most vulnerable. Understanding why differences in bioaccumulation occur and if they predict likelihood of adverse effects are important questions. Monitoring programs ultimately should focus on those species most likely to achieve the highest dose of metal/lloid.
4. One of the first things that is important to know is the likelihood of metal bioaccumulation from food (trophic transfer). The mechanisms governing uptake (specifically absorption efficiency and loss rates) allow generalizations about which metals are likely to be most effectively trophically transferred, for which species (see below).

Trophic transfer potential

$$\text{TTP} = \frac{[\text{Ingestion rate} * \text{Absorption efficiency}]}{[\text{rate constant of loss} + \text{growth rate}]}$$

$$\text{TTP} = \frac{[\text{IR} * \text{AE}]}{K_e + g}$$

Metals with slow loss rates are strong candidates for trophic transfer, where absorption efficiencies are above 10%. Trophic transfer potential also increases for biological species with high ingestion rates. Biomagnification is expected for methyl mercury and selenium, based upon these principles, and could be common for cadmium, zinc, and perhaps even silver. Upper trophic levels, as well as lower trophic levels, should be studied for food webs and metals for which trophic transfer is most likely.

5. Developing new experimental designs is also critical in defining effects of metals that better reflect circumstances in nature. Some simple principles are important :

- a.** Assure that the balance between dissolved and dietary exposure is close to natural conditions. For example, short spiking periods greatly accentuate pore water metal concentrations in sediments and bias results toward results confounded by unrealistic pore water exposures. Monitoring programs should anticipate longer-equilibration-type conditions.
- b.** All food sources should be spiked. For example, spiking sediments and supplemental food in sediment bioassays yields very different uptake than when diets are unsupplemented or supplemented with unspiked food. In nature food sources are contaminated and monitoring food can be an important in evaluating upper trophic level exposures.
- c.** Choice of food is critical. It is well established that bioavailability varies widely among food sources. Dietary studies of effects should be preceded by some preliminary test of bioavailability from the food source (absorption efficiency). For example, silver appears to be of relatively low bioavailability from supplemental tetramin. Effects of dietary silver were evident (after 90 days) at concentrations feasible in polluted sediments, when sediments were supplemented with spiked algal cultures, however (Lee, pers. comm.). Without preliminary verification of bioavailability from a food source, study of effects from that food source could be a waste of time. Similarly, generalizations about effects from “diet” cannot be made based upon studies from only one food source, especially if it is not a natural source. In transplanting animals for monitoring, conditions must be suitable to allow feeding and exposure to a diet similar to what occurs under natural conditions.
- d.** Animals differ in what they eat. Concentrations in the food source in nature may also vary widely, and will affect exposure of predators or consumers, which will affect the ultimate effects on the population. Monitoring animals and their predators that receive the largest dose of metals is preferential in most circumstances.
- e.** Short-term (acute) experiments are less likely to illustrate dietary effects than long term experiments, closer to simulation of exposures in nature, although the mechanism behind this is not fully understood.
- f.** Experimental designs (field or lab) and monitoring programs, thus should consider the metal- and species-specific sublethal response that is expected, what an organism might eat in nature, and internal factors that might affect both the response and the bioavailability from food. All of these require mechanistic understanding of ecology and biology at the basic level.

Effects of heavy metals on signal transduction and consequent toxic effects

A. Viarengo*, B. Burlando, F. Dondero

* *Istituto di Fisiologia Generale, Università di Genova, Italia*

It is well known that pollutants may alter organism physiology by acting at molecular level and therefore impairing cell and organism functions.

It is usually thought that pollutants, such as heavy metals and organic aromatic xenobiotics, exert their noxious effects by acting directly on enzymatic proteins, organelle structures, etc.

It has also been found that some xenobiotics affect the endocrine balance of organisms. Different findings have shown endocrine disruption in aquatic organisms such as fish and molluscs. In these latter organisms, this produces in some cases a change in the sex characteristics of the organism (imposex).

More recently, it has been hypothesized that not all the toxic effects of pollutants at cellular level are depending on the direct effects of toxic chemicals but, that a large part may depend on the alterations of signal transduction pathways. This kind of pollutant effects should render cell and organism “deregulated”, leading to activities that may not be coherent with the animal physiological and environmental adaptations.

Following the increment of knowledge about cell signal transduction pathways, stress signalling has become an attractive field. For instance, it has been found that heavy metals and pro-oxidants can interact with different cell plasma membrane receptors (Gamou and Shimizu, 1995; Huang *et al.*, 2000, 2001; Koshio *et al.*, 1988; Narahashi *et al.*, 1994; Smith *et al.*, 1989). In particular, these chemicals are able to impair cell tyrosine kinase activities (Lander *et al.*, 1992; Rahman *et al.*, 1993) and free cytosolic calcium (Katano *et al.*, 1995; Nakashima *et al.*, 1994; Schieven *et al.*, 1993). Several exogenous chemicals can affect Ca²⁺ dynamics and homeostasis. The toxicity or pathogenic activities of different agents may depend entirely or in part from a deregulation of cell Ca²⁺, leading to Ca²⁺ cytotoxicity and cell death (Ermak and Davies, 2002; Kass and Orrenius, 1999; 20. Viarengo and Nicotera, 1991). On the other hand, it has been also reported that cell stress may lead to the activation of MAP kinases (Bhat and Zhang, 1999; Dabrowski *et al.*, 2000; Hansson, 1996; Poonam *et al.*, 2002; Samet *et al.*, 1998; Wu *et al.*, 1999), as well as of the JAK/STAT system (Simon *et al.*, 1998).

This kind of findings is relevant for a series of pathologies where pro-oxidant conditions are known to produce injurious effects or promote specific cell responses. Yet, heavy metals and pro-oxidants also represent important and ubiquitous environmental bio-hazard that are increasing in concentration in different environments due to human pollution. Hence, potential alterations of tyrosine kinase signalling could explain a wide spectrum of noxious effects and pathologies that

these compounds are known to produce on different organisms. Moreover, cells could become less able to correctly respond to hormonal stimuli and also to produce adequate endocrine responses to pollutants.

We presented data showing that in both fish and molluscs, heavy metals (Hg, Cu, Zn and Cd) and pro-oxidant compounds are able to alter fundamental cell signaling pathways related to the tyrosine-kinase cascade and cytosolic free calcium and cAMP concentrations. In RTH 149 trout hepatoma cells, exposure to Cu, Hg or H₂O₂ for 5-10 min causes a net increase of tyrosine phosphorylation in different proteins. The use of phosphospecific antibodies also indicated that these agents activate homologues of the different families of MAP kinases, as well as of STAT1 and STAT5.

It has also been demonstrated that the alteration of Ca²⁺ homeostasis in mollusc cells is directly related to the activation of the lysosomal vacuolar system. Data show that both physiological hormonal stimuli (i.e. 17 b estradiol) and pollutants, such as heavy metals (Cu, Hg) are able to increase the cytosolic free calcium concentration, leading to the activation of Ca²⁺-dependent phospholipase A2. This enzyme is responsible for lysosome membrane destabilization, increasing lysosome fusion rates and ultimately leading to an increase of protein catabolism (see Fig. 1). The reported data clarify the cellular mechanism of the well known pollutant effect on lysosomes, the lysosomal membrane stability being a well recognized biomarker used in biomonitoring programs to evaluate a stress syndrome on selected sentinel organisms.

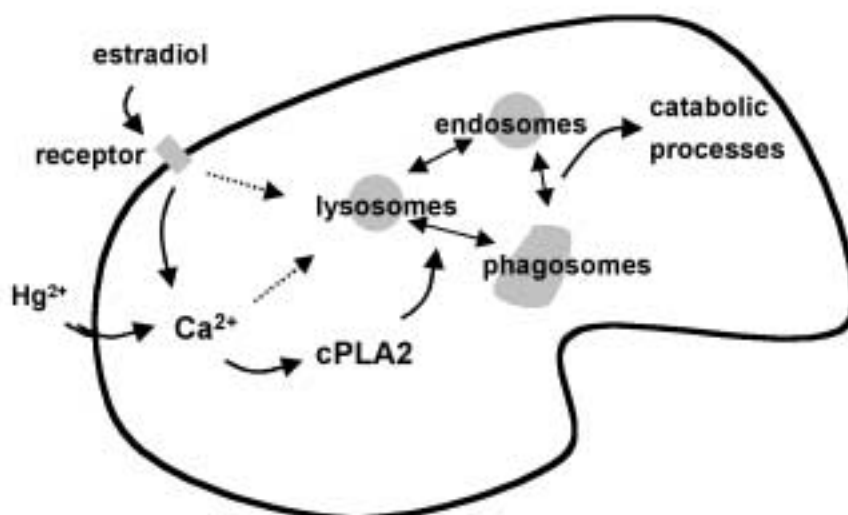

Fig. 1. Diagram showing the cellular mechanisms of lysosome membrane destabilization by hormone and heavy metal.

Metal speciation in cephalopods: implications for bioaccumulation in marine top predators

P. Bustamante and F. Caurant

*Laboratoire de Biologie et Environnement Marins, UPRES-EA 3168,
Université de La Rochelle, France*

INTRODUCTION

Among marine organisms, cephalopods have been poorly investigated from the contamination point of view, whether contaminants were elemental or organic. This lack of interest for cephalopods in biomonitoring programs seems to be mainly due to the biology of the species, most of them being migratory and/or relatively difficult to sample. However, cephalopods are of great importance both from the ecological and human consumption point of view.

Indeed, cephalopods constitute a class of marine molluscs which is important in terms of species number, with around 700 known and 175 fished (Guerra, 1992). They are found to live in all types of marine habitats, from coastal waters to open ocean, from epipelagic to abyssal environments, including hydrothermal vents, and from the polar regions to the tropics. They are benthic (octopuses), nectobenthic (cuttlefishes), neritic and pelagic (squids). Therefore, they constitute a primary food source for many marine predators: fish, seabirds and marine mammals (reviewed by Clarke, 1996; Croxall and Prince, 1996; Klages, 1996; Smale, 1996). In marine mammals, they have such a high importance that over 80% of odontocete and seal species regularly include cephalopods in their diet and they comprise the main food in 28 odontocete species. Thus, interest in the bioaccumulation of trace elements in cephalopods stems from their role as important prey organisms for top marine predators (Bustamante *et al.*, 1998).

Furthermore, trace elements in cephalopods which are extensively fished also raise public health concerns due to their consumption by humans as seafood. Indeed, cephalopod fisheries have been developed in the last decades to exploit new stocks as alternative fisheries and to answer to a modification of populations feeding habits. For most of the fished species, only the muscular parts, mantle, fins and arms are consumed. However, in some countries, cephalopods are whole-eaten (e.g. small squids called “chipirones” in Spain) or, after maceration of the whole animal, used as squid sauce. But this aspect of public health has retained very little attention to date.

In many marine mammals and several seabirds, Cd and Hg have been reported to accumulate at very high levels in kidney and liver, respectively (Furness, 1993; Aguilar and Borrell, 1996). Such high levels are known to provoke physiological alterations in humans and raise concern about the effect on their survival, particularly in association with other threats including direct exploitation, incidental mortality and destruction of habitat. However, these high levels seem to

be natural as in remote areas like oceanic islands or polar zones, where marine mammals and seabirds also display high metallic values. In these vertebrates, essential elements are submitted to homeostatic processes, leading to stable levels throughout their life span. The only exception for this axiom is Se, which is accumulated in liver with age as a consequence of its co-precipitation with Hg (Cuvin-Aralar and Furness, 1991; Nigro and Leonzio 1996).

All persistent contaminants are incorporated in the body of top marine predators via food. Consequently, diet is the first factor controlling the metal intake (Aguilar *et al.*, 1999). Transfer of trace elements from a prey to a predator greatly depends on the bioavailability of the metal that is determined by the detoxification processes in preys. It is largely admitted that metals located in the cytosolic fraction are highly bioavailable to higher trophic levels, whereas those bound to the insoluble subcellular fraction have a lower potential for transfer to predators (Wallace and Lopez, 1997). Consequently, the different physico-chemical forms of metals in preys appear to be a key factor that might control the metal bioaccumulation in top marine predators.

WHAT DO WE KNOW CONCERNING METALS IN CEPHALOPODS ?

Most of the studies on bioaccumulation of trace elements in cephalopods mainly concern levels and distribution of essential elements such as Cu or Fe, and to a lesser extent toxic elements. Many focus on a single organ, primarily on the digestive gland for its liver-like function (i.e. digestive and storing) but the branchial hearts and appendages have also drawn attention for their implication in the excretion processes (Miramand and Bentley, 1992). However, Cd, Zn and Am metabolisms received most attention and have been better understood compared to other trace elements (Guary and Fowler, 1982; Ueda *et al.*, 1985; Koyama *et al.*, 2000; Bustamante *et al.*, 2002a).

All of these studies have clearly shown that cephalopods have in common the ability to concentrate both essential and toxic metals. However, several factors might influence trace element concentrations within a species (e.g. sex, age, maturity stage) and among species (e.g. taxonomy, way of life or geographical origin). Cadmium, copper and zinc concentrations show high variability in cephalopods with respect to families, geographical origin and feeding habits (benthic or pelagic). Generally, octopuses show the highest concentrations while squids have the lowest (Fig. 1).

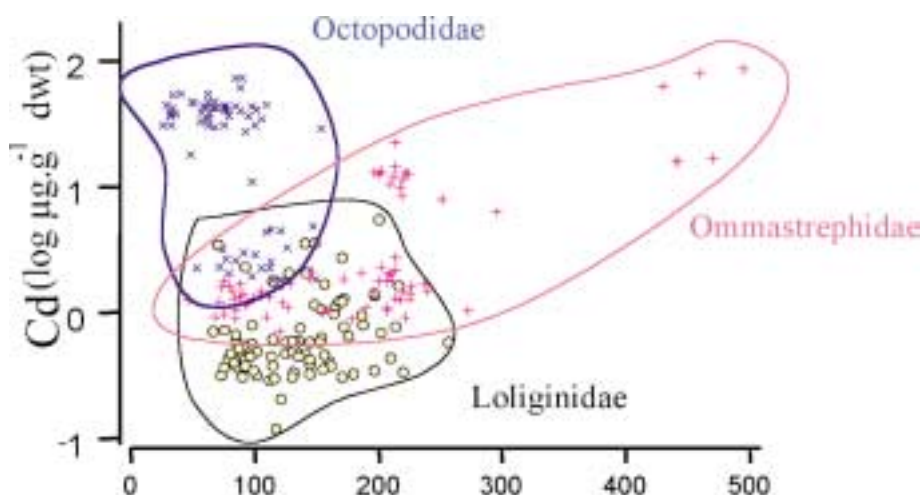

Fig. 1. Cd concentrations ($\log \mu\text{g}\cdot\text{g}^{-1}$ dwt) in three cephalopod families as a function of mantle size (mm).

Besides, one of the most important findings is that cephalopods show large differences in Cd concentrations depending upon their origin, levels being several times higher in polar and sub-polar areas (Fig. 2). In all cephalopod species, independently of origin, Cd is stored in the digestive gland, bound to cytosolic proteins (Butamante *et al.*, 2002b). However, species with the highest total Cd concentrations show a higher percentage of the metal associated to insoluble compounds (Fig. 3).

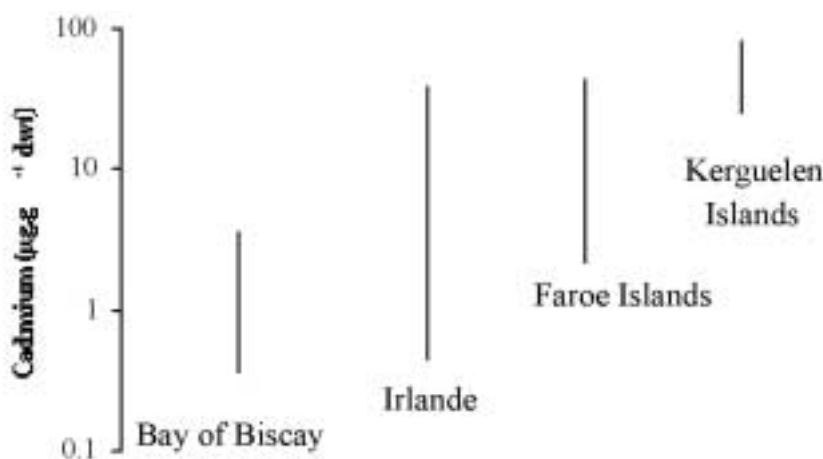

Fig. 2. Range of Cd concentrations ($\mu\text{g}\cdot\text{g}^{-1}$ dwt) in various cephalopods from temperate (Bay of Biscay and west Ireland shelf) and subpolar regions (Faroe and Kerguelen Islands)

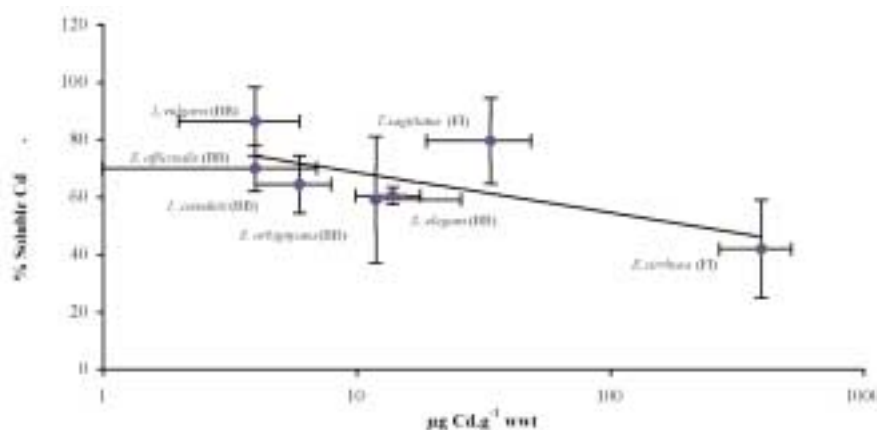

Fig. 3. Partitioning of cadmium (as % of soluble Cd) in the digestive gland of cephalopods as a function of total cadmium levels in this organ (expressed as $\mu\text{g}\cdot\text{g}^{-1}$ ww). Scale bars represent one standard deviation. BB : Bay of Biscay; FI: Faroe Islands (From Bustamante *et al.*, 2002b).

Finally, concerning Hg, very little information is available on factors influencing their concentrations in cephalopods. It is largely admitted that cephalopods have low Hg concentrations compared to fish but this is supported by very few studies and has to be confirmed for various ecosystems. Furthermore, cephalopods also appear to have lower methyl-Hg contents than fish (Cappon and Smith, 1982). But globally, there is a lack of information about the physico-chemical form of inorganic mercury within cephalopods.

IMPLICATIONS FOR MARINE TOP PREDATORS

Cephalopods have been considered as a significant Cd source for their predators, marine mammals (Honda *et al.*, 1983) and seabirds (Muirhead and Furness, 1988), particularly at high latitudes such as the Austral Ocean where numerous seabird species feed on cephalopods (Bustamante *et al.*, 1998). Cd is mainly accumulated in kidney where it provokes tubular dysfunction above a threshold value of $50\ \mu\text{g}\cdot\text{g}^{-1}$ ww (Elinder and Järup, 1996). For example, renal Cd in grey-headed albatrosses from the Kerguelen Islands could reach $157\ \mu\text{g}\cdot\text{g}^{-1}$ ww (personal data) or $500\text{-}900\ \mu\text{g}\cdot\text{g}^{-1}$ ww in the oldest pilot whales from Faroe Islands (Caurant, 1994).

Knowing the diet and the daily food rates of the predators, it is possible to evaluate their daily intakes of Cd. Thus, teuthophageous predators from polar and subpolar areas are strongly exposed to Cd through cephalopod consumption and the ingested doses are often far in excess of the admitted maximal dose for humans (Bustamante *et al.*, 1998).

It has been widely accepted that cephalopods contribute to high Cd exposure for their predators while fish consumption would better explain Hg exposure. This theory was based on the fact that cephalopods have low methyl-Hg contents compared to fish (i.e. from 29 to 55% vs 53 to 94%, respectively) for which biomagnification is significant. Contrary to inorganic-Hg, Me-Hg is highly assimilated through enterocytes but is demethylated in liver throughout the life span, subsequently leading to the formation of mercuric selenide (HgSe) granules (Koeman *et al.*, 1973). HgSe granules (tiemannite) have been identified in the liver of seabirds, marine mammals and humans (Martoja and Berry, 1980; Nigro and Leonzio, 1996).

Efficiency of the demethylation process seems to be more dependent of the speciation of Se within the food than of the quantity of the metal. Experimentally, selenate (Se⁶⁺) has been shown to be less efficient to prevent Hg toxicity than selenite (Se⁴⁺) or organic Se (Magos *et al.*, 1987). In cephalopods, Se is mainly found under selenite form while in fish, selenate is the predominant one (Capon and Smith, 1982; Cappon, 1990). Consequently, cephalopod consumption might supply more efficient physico-chemical forms of Se to provoke the demethylation processes than fish do.

CONCLUSION

Top marine predators are naturally submitted to very high Cd exposure when they include cephalopod in their diet. They often display very high Cd and Hg concentrations in their tissues without evidence of related population threats or histological damages. For this reason, it has been supposed that they have evolved very efficient metal detoxification processes to counteract the toxicity of both elements.

However, as discussed for Se, speciation of Cd and Hg has to be investigated more deeply in cephalopods as well as in fish. This will provide new information necessary to better understand and characterise the bioaccumulation processes in top predators leading to such high Cd and Hg concentrations in their tissues. Finally, it will improve the modelling of metal bioaccumulation in marine mammals.

Unusual bioaccumulation of arsenic in the polychaete *Sabella spallanzanii* and oxidative damages of metals in marine invertebrates

R. Bocchetti, D. Fattorini, S. Gorbi, N. Machella and F. Regoli*

**Institute of Biology and Genetics, University of Ancona, Italy*

This extended and informal abstract introduces some aspects which are actually investigated at the Institute of Biology and Genetics, University of Ancona. General interest shown by the scientific community regarding arsenic in the marine environment has always been associated with the toxic characteristics of its compounds. Arsenic toxicity has been interpreted by several authors as a “molecular imitation”; in fact, arsenate ions can be implicated in most metabolic processes, including ADP phosphorylation where phosphate ions are replaced, thus causing these processes to fail (De Master and Mitchell, 1973; Kenney and Kaplan, 1988). Other toxic effects investigated were formation of oxidative DNA adducts and DNA-protein cross-links, mediated by arsenite ions (Wang *et al.*, 2001). However it is well-known that arsenic toxicity is correlated with the chemical form that this element can assume; the most toxic species are inorganic compounds such as arsenite (As^{III}) and arsenate (As^{V}), while methylated compounds such as methyl-arsenate (MMA), dimethyl-arsinate (DMA), trimethyl-arsine oxide (TMAO) and tetramethyl-arsonium (TETRA) are considered moderately toxic. Non-toxic species are the organic compounds including arsenobetaines (AsB), arsenocholines (AsC) and arsenosugars (AsS) (Gailer *et al.*, 1994; Dagnac *et al.*, 1998). Given the importance of arsenic as an environmental pollutant, it is fundamental to distinguish between the toxic and non-toxic forms in the environment where high levels of this element can generally be found.

Aquatic organisms can easily uptake arsenic from environment and in many conditions this metal is accumulated at high levels; distribution of As^{V} , As^{III} , MMA, DMA, AsB and AsC was investigated in various species of bivalve molluscs (Gailer *et al.*, 1994; Dagnac *et al.*, 1998; Lai *et al.*, 1999; Vilanò and Rubio, 2001), including mussels and oysters where the non-toxic AsB is by far the most represented form; novel forms of AsS were identified in some gastropod species (Francesconi *et al.*, 1998). The presence in these species of organic non-toxic forms is often interpreted as possible detoxification products of environmental arsenic. On the contrary, it has been recently demonstrated that the polychaete, *Arenicola marina*, can accumulate quite large quantities of arsenic which are mainly present as inorganic compounds, tracing an unusual aspect of this species (Geiszinger *et al.*, 2002).

Another polychaete species, *Sabella spallanzanii*, has been investigated in our laboratory. This species is commonly found throughout the Mediterranean Sea in shallow sheltered areas and no deeper than 30 meters in more exposed waters. It produces a tube which is usually attached to hard surfaces, and feather-like filaments can be extended out beyond the protection of the tube.

The sessile habit, the filter-feeding behavior and its capability to disperse and colonize disturbed environments such as harbors, suggested the potential for this organism as a bioindicator for monitoring marine environmental quality. In preliminary work, we have determined trace metal concentrations (As, Cd, Cr, Cu, Fe, Mn, Ni, Pb, Zn) and carried a biochemical analysis of antioxidant defenses (superoxide dismutase, catalase, glutathione peroxidases, glutathione S-transferases, glutathione reductase and Total Oxyradical Scavenging Capacity) in *S. spallanzanii*. Organisms were collected in four locations of the Adriatic and Tyrrhenian seas, characterized by a moderate impact or influenced by organic enrichment or sulphuric emissions. Trace metal concentrations were generally comparable to those of other invertebrate species and quite typical for unpolluted environments. However, exceptionally high concentrations of arsenic were measured in the branchial crown ($> 1000 \mu\text{g/g d.w.}$) with values much greater than those measured in the thorax (approximately $50 \mu\text{g/g d.w.}$) and reported for other invertebrate species. The chemical speciation was investigated by high performance liquid chromatography (HPLC) separation and atomic absorption spectrometry (AAS) determination; the certified reference material DORM-2 was used to validate the speciation procedure. Our results indicated a quite unusual distribution of arsenic compounds in *Sabella spallanzanii*, with DMA as the most represented species ($>80\%$) and AsB lower than 5%. In light of the relative toxicity of DMA (LD_{50} in rats: 1350 mg/Kg) (Bailey and White, 1965), distribution of As in *S. spallanzanii* represents a peculiar characteristic for this species which could be interpreted as a defense strategy against predation. Although biosynthetic pathways of arsenic compounds are largely unknown, it has been demonstrated that methylation reactions are mediated by glutathione and glutathione S-transferases, which both represent important components of the cellular antioxidant system. In this respect, the antioxidant profile of *S. spallanzanii* revealed that, compared to the thorax, the branchial crowns were characterized by higher enzymatic activities of superoxide dismutase, glutathione S-transferases, glutathione reductase and glutathione peroxidases and also a greater efficiency in absorbing peroxy radicals.

GSH and the other components of antioxidant system play an important role in the metabolism of trace metals in marine invertebrates and a close correlation between these chemical and biochemical parameters has been documented in several bivalve populations from different geographical areas including Mediterranean, Arctic and Antarctic environments (Regoli, 1998; Regoli *et al.*, 1998a,b), polluted and control sites (Regoli, 2000), field and laboratory conditions (Regoli and Principato, 1995). Trace metals can both increase the intracellular generation of oxyradicals through Fenton-like reactions and interfere with efficiency and availability of cellular antioxidants, perturbing the redox status of the organism and possibly leading to impairment of various cellular functions.

Mussels exposed to metals in both field and laboratory conditions revealed variations in some antioxidants parameters although the comparison between native and transplanted populations suggests also the occurrence of some adaptation or compensatory mechanism in chronically polluted organisms.

Trace metals can induce alterations to other cellular compartments, including destabilization of lysosomal system and occurrence of DNA damage (Regoli, 1992; Frenzilli *et al.*, 2001). Various forms of lysosomal perturbation can be measured in metal exposed organisms and a complex relationship appears between metal accumulation, detoxification and excretion pathways, oxyradical formation, variation of antioxidant defenses and occurrence of peroxidative reactions.

Exposure to environmentally high levels of copper induced significant increase of genotoxic damages in mussels. Such effects are not caused by a direct interaction of copper with DNA but, at least partly, mediated by an indirect mechanism involving formation and reactivity of oxyradicals; high levels of 8-oxo-d-guanosine were measured in Cu polluted mussels, clearly indicating oxyradical attack to DNA. An oxidative mediated pathway of DNA damage in metal exposed mussels is confirmed also by the correlation between loss of DNA integrity and reduced capability to neutralize hydroxyl radicals (Frenzilli *et al.*, 2001).

Bioaccumulation and biological effects of trace metals are of particular interest also in key species from remote and extreme environments where the knowledge of baseline levels is par-

ticularly needed. Within the Italian Antarctic Project, the levels of trace metals have been characterized in several invertebrates from the area of Terra Nova Bay (Nigro *et al.*, 1997), where high levels of cadmium have been generally observed. The scallop *Adamussium colbecki*, which is indicated by SCAR as one of the most important bioindicator organisms, has been largely investigated in the factors influencing bioaccumulation of trace metals as well as toxic effects of these elements (Regoli *et al.*, 1997, 1998b, 2000). In the next two years, within the International Project “Victoria Land Transect”, a large scale study will be carried out to investigate latitudinal variations at all the levels of biological organization (from molecule to community structure) including trace metal accumulation in selected target species.

Bioaccumulation of inorganic and organic mercury and organolead compounds in marine organisms

Nevenka Mikac

Center for Marine and Environmental Research, Rudjer Boskovic Institute, Zagreb, Croatia

INTRODUCTION

An important factor in understanding the metal biogeochemical cycles is the knowledge on the bioavailability and trophic transfer of metals in the marine food chain. Recent research in the area demonstrated that numerous factors influence bioaccumulation of particular metals into marine organisms (Fisher and Reinfelder, 1995). One of the most important factors is the chemical characteristics of metals which regulate their speciation in different environmental compartments. Of special interest are metals which form organometal compounds stable under environmental conditions, as are Hg, Sn and Pb. Due to their more covalent nature and thus higher lipophilicity, organometal compounds usually accumulate more efficiently and are more toxic than inorganic forms of the same metal (Pelletier, 1995). Among the metals Hg represents a special case, as it is the only metal for which widespread methylation (formation of mono- and dimethyl mercury) in aquatic systems (primarily sediments) is recognised and whose elemental form (Hg^0) exists in nature. In addition, the behaviour of inorganic mercury differs from other Group IIb metals because of the covalent nature of its compounds with halides (HgCl_2) and sulfide (HgS), which are thus non-polar and have a relatively high octanol-water partition coefficient (Wright and Mason, 2000). Lead also forms organometal compounds relatively stable under environmental conditions (ethyl and methyl derivatives of tetra, tri- and dialkyl lead), which are however, in contrast to organic mercury, not formed in the environment, but introduced to it by the anthropogenic activity (use of tetraalkyllead as additive in gasoline). The bioaccumulation and biomagnification of organic and inorganic mercury, as well as organolead compounds in the marine organisms will be briefly presented here.

BIOACCUMULATION OF MERCURY COMPOUNDS

Mercury is accumulated by aquatic plants and organisms and the concentration tends to increase with increasing trophic level (mercury biomagnifies). The form of mercury which is actually biomagnified is methylmercury, whose percentage increases from phytoplankton (<10%) and invertebrates (generally <20%) to fish (>90%). Both inorganic and organic mercury are taken up easily and quickly by organisms, but methylmercury depurates much more slowly than inorganic mercury (Mikac *et al.*, 1996a). Recent research by Mason and co-workers (Wright and Mason, 1995; Mason *et al.*, 1995; Lawson and Mason, 1998) offers basic explanations of the preferential bioaccumulation of organic over inorganic mercury. They showed that passive uptake of lipophilic complexes (primarily HgCl_2 and MeHgCl) is the controlling accumulation mechanism for phytoplankton and microorganisms (Fig. 1). Differential bioaccumulation of

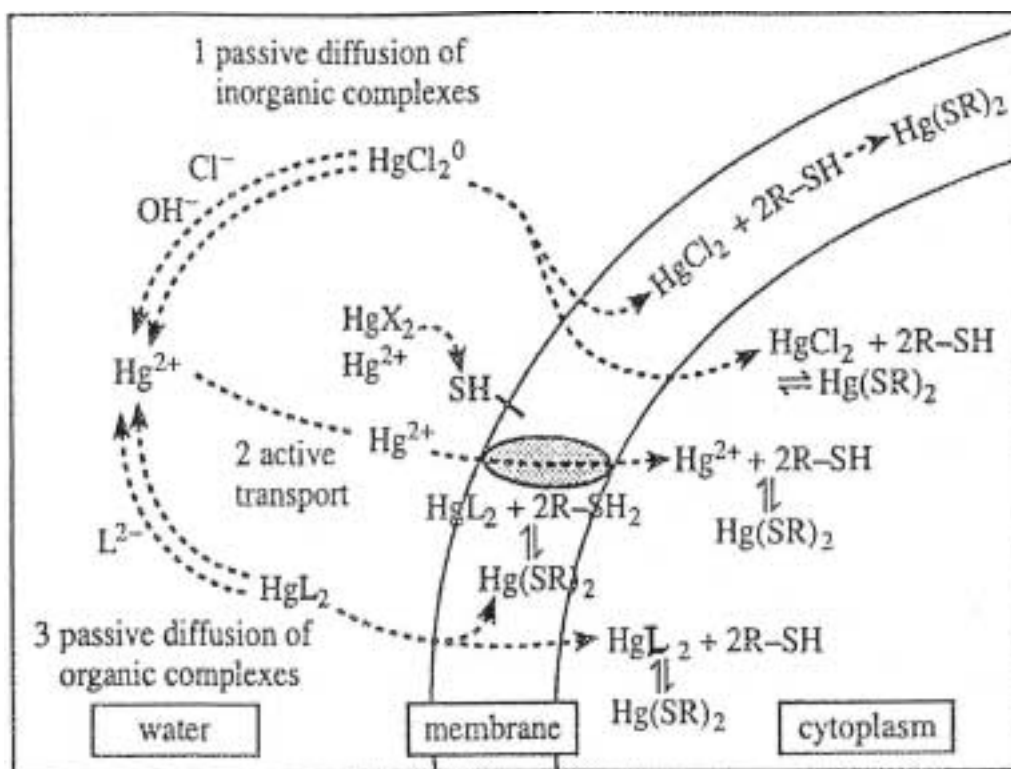

Fig. 1. Scheme describing factors influencing the bioaccumulation of inorganic and organic mercury (from Wright and Mason, 2000).

organic and inorganic mercury is explained by different proportion of each that are present as neutral complexes (in seawater nearly 100 % of methylmercury is as MeHgCl while only 3% of the inorganic mercury is HgCl_2) and by the greater assimilation efficiency of methylmercury over inorganic mercury by zooplankton (due to preferential partitioning of methylmercury into the cytoplasm of phytoplankton cells). Fish assimilate methylmercury more efficiently than inorganic mercury owing to larger fraction of methylmercury in the soft tissue of zooplankton, leading to further discrimination up the aquatic food chain (Lawson and Mason, 1998; Mikac *et al.*, 1985). However, our knowledge of the fundamental physiological and biogeochemical mechanisms of mercury uptake and excretion is still inadequate, making it very difficult to set up predictive models of methylmercury bioaccumulation as a function of environmental factors.

BIOACCUMULATION OF ORGANOLEAD COMPOUNDS

The occurrence of organolead compounds in the environment has received much less attention than organomercury and organotin species, and many aspects of their occurrence and their fate in aquatic systems are still largely unknown (Pelletier, 1995). Especially data on occurrence of alkylleads in living organisms and trophic transfer of organolead compounds through aquatic ecosystems are scarce. It was shown that fish living in the vicinity of alkyllead manufactures could accumulate high concentrations of ethyllead compounds comprising up to 75 % of the total lead (Pelletier, 1995). Data for marine organisms not directly exposed to alkylleads are very limited. The accumulation of lead compounds into marine organisms was studied in the mussel *Mytilus galloprovincialis* and different fish species from the Adriatic sea (Mikac *et al.*, 1996b; Mikac *et al.*, 2001). The presence of all alkyllead species in mussels tissues was established, with a dominance of ethyl derivatives (Fig. 2). The target organs for accumulation of organic lead in mussels were viscera and mantle and for inorganic lead just viscera. Distribution of lead compounds in fish demonstrated that organic lead was more equally distributed between muscle and intestine, compared to the total lead which was accumulated primarily in the intestine. Bioconcentration factors between mussels and seawater were lower for alkyllead compounds than those for the total lead, indicating less efficient bioaccumulation of organic lead. For both

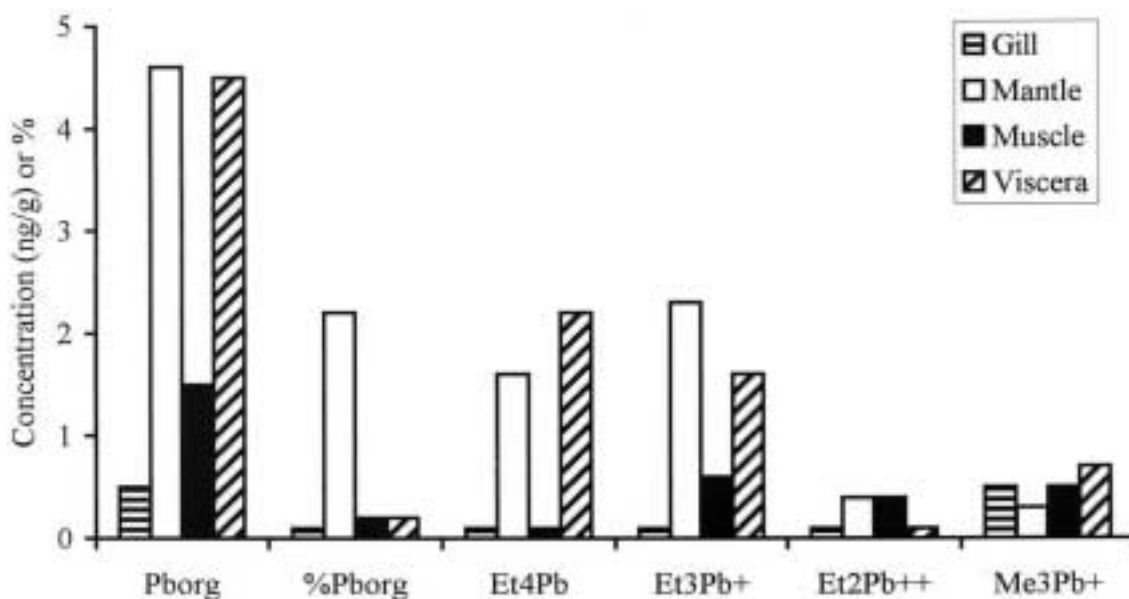

Fig. 2. Distribution of organic lead in mussels *Mytilus galloprovincialis* from the Adriatic Sea.

total and organic lead, concentrations in organisms and bioconcentration factors between organisms and seawater were much higher in mussels than in fish, indicating the absence of biomagnification for both lead species.

CONCLUSION

These two examples demonstrate that the lipophilic nature of organometal compounds does not necessarily lead to higher bioaccumulation of these compounds in marine organisms, compared to the inorganic metal forms. For each organometal species stability and reactivity under environmental conditions, as well as biotransfer and recycling mechanisms in the marine trophic network, should be known in order to understand the environmental fate and behavior of these compounds and establish appropriate water and sediment quality criteria.

Scope of methylmercury turnover in organisms: towards a general model of biokinetics?

Markus Meili

Stockholm University, Inst. of Applied Environmental Research (ITM), Stockholm, Sweden

Recent years have brought a lively debate of scale-invariant properties in organism physiology, ecosystem structures, and landscape formations (e.g. Whitting, 1995; West *et al.*, 1997; 1999; 2002; Banavar *et al.*, 2001; 2002; Hendriks, 1999; Enquist and Niklas, 2001; 2002; Niklas and Enquist, 2001; Gisiger, 2001; Jeong *et al.*, 2000; Reich, 2001; Allen *et al.*, 2002; Andresen *et al.*, 2002; Brown *et al.*, 2002). Among the most frequently addressed issues are allometric relationships of biological turnover rates, in particular metabolic rates, with organism size. This is an issue with a long history (Rubner, 1883; Kleiber, 1932; Brody, 1945; Hemmingsen, 1960; Kleiber, 1961; Peters, 1983; West *et al.*, 1997; Gillooly *et al.*, 2001; Dodds *et al.*, 2001; Darveau *et al.*, 2002). New interest has been inspired among other by an elegant attempt to link metabolic scaling to the fractal geometry of transport networks (West *et al.*, 1997; Gillooly *et al.*, 2001; Banavar *et al.*, 1999-2002). This approach gives support to the “quarter-power law” implying that whole-body rates change with body weight according to $W^{3/4}$, and mass-specific rates according to $W^{-1/4}$. This rule is supported by considerable empirical evidence, but both its generality and its theoretical basis are still questioned (Peters, 1983; 1996; Tang and Peters, 1995; Bishop, 1999; Dodds *et al.*, 2001; Hu and Hayton, 2001; Darveau *et al.*, 2002; Weibel, 2002; Burness, 2002). Alternative power exponents frequently referred to are 2/3 (“surface law”; Rubner, 1883; Hemmingsen, 1960; Dodds *et al.*, 2001), 0.8 (e.g. Peters, 1983), and 1 (proportionality of rates and mass).

While recent attention has been focused on structural and energetic aspects of ecosystems, less attention has been paid to the turnover of major cell constituents and trace substances including contaminants, although similar allometric relationships with organism size have been reported (e.g. Peters, 1983; Hendriks, 1995, 1999; Hendriks and Heikens, 2001; Hendriks *et al.*, 2001; Singer, 2001; Hu and Hayton, 2001). Since material turnover is largely a matter of biological transport, the quarter-power law is particularly attractive to address not only supply but also removal rates. These rates, which can also be expressed as equilibration half-times (elimination half-lives), apparently scale to organism size with power exponents similar to those of metabolic rates (Ugedal *et al.*, 1992; Hendriks, 1995; Hendriks and Heikens, 2001; Hendriks *et al.*, 2001; Rowan and Rasmussen, 1995; Trudel and Rasmussen, 1997; Singer, 2001). Such relationships are of considerable interest, even if the causal link between contaminant turnover and metabolic rate as well as the similarity of their allometric relationships with organism size remain to be clarified.

Apart from organism size, body temperature is a key factor influencing metabolic turnover rates (e.g. Hemmingsen, 1960; Peters 1983; 1996; Wen and Peters, 1994; Gillooly *et al.*, 2001).

This influence is frequently described by an exponential relationship showing an acceleration by 2- to 3-fold per 10°C, and can be elegantly linked to chemical reaction kinetics (Arrhenius or van't Hoff equation). Thus, according to Gillooly *et al.* (2001), the rate at which organisms transform energy and materials is governed largely by two properties: the Boltzmann factor, which describes the temperature dependence of biochemical processes, and the quarter-power allometric relation, which describes how biological rates scale with body size. In this way, environmental observations can be linked to fundamentals of physics and chemistry by simple relationships. Such relationships are useful for developing general scaling models that may be applicable over the whole size range from molecules and cells to invertebrates and mammals (Hendriks, 1999; Nisbet *et al.*, 2000; Niklas and Enquist, 2001; West *et al.*, 2002) and over the ecologically relevant temperature range from 0°C (Arctic seas) to 35-40°C (body temperature of endotherms such as mammals and birds).

Similar temperature relationships appear to govern also the equilibration half-times of at least some contaminants, in particular methylmercury and radiocesium (Ugedal *et al.*, 1992; Rowan and Rasmussen, 1995; Trudel and Rasmussen, 1997; Forseth *et al.*, 1998). This supports the notion that material turnover is largely controlled by the general metabolic turnover, even in the case of non-essential contaminants and apparently passive uptake.

Some general patterns of contaminant turnover in biota can thus be examined by assuming proportionality with metabolic rate. One aspect of interest is the scope of contaminant turnover rates, within or among organisms and ecosystems, over a body temperature range from 0 to 40°C and an organism weight range extending over 22 orders of magnitude (Fig. 1). These ranges cover most organisms including ectotherms ranging from bacteria to whale sharks, and endotherms ranging from shrews and colibris to blue whales.

Such an approach is here applied to methylmercury by scaling a metabolic model (Gillooly *et al.*, 2001) to methylmercury equilibration half-times observed in fish (Trudel and Rasmussen, 2001), with the following underlying assumptions:

- maintenance metabolism is proportional to the resting or basal metabolism;
- natural metabolism including that for growth and activity is proportional to above;
- methylmercury metabolism is proportional to above;
- methylmercury turnover is about 3-fold slower than biomass turnover, given similar assimilation efficiency and a biomagnification factor of around 3 (Meili, 1997).

The resulting estimates (Fig. 1) suggest the following scopes for the biological equilibration half-time of methylmercury (slowest component, long-term):

- total scope in living organisms: 6-7 orders of magnitude;
- fish: from <10 days (tropical juveniles) to >100 y (adult sharks in cold waters);
- macroinvertebrates: from <1 day (tropical zooplankton) to >5 years (inactive lobsters or jellyfish in cold waters);
- microorganisms: from <1 hour (active bacteria) to >1 week (inactive inv. larvae);
- ectotherms: from <1 hour (active bacteria) to >100 years (inactive sharks);
- endotherms: from <3 days (juvenile colibris) to >3 years (inactive whales).

It may be noted that in warm waters, metabolism is accelerated in ectotherms, but slowed down in endotherms if less energy is required for thermoregulation.

Experimental data obtained from fundamentally different organisms exposed to radiolabelled methyl²⁰³mercury in laboratory systems (cf. Sjöblom *et al.*, 2000) largely follow predicted patterns (Fig. 1). This confirms that methylmercury may be a prime example of a contaminant with a turnover that is largely controlled by biological processes (e.g. Meili, 1997). However, principles and patterns outlined here may at least to some extent apply also to other substances (cf. Wang, 2002).

It may be speculated if metabolic models also can apply to dead organic matter in the form of particulate detritus and colloidal or dissolved organic substances, which constitute the dominating organic matrix in most waters. Extreme conditions where metabolic activity is minimal (cf.

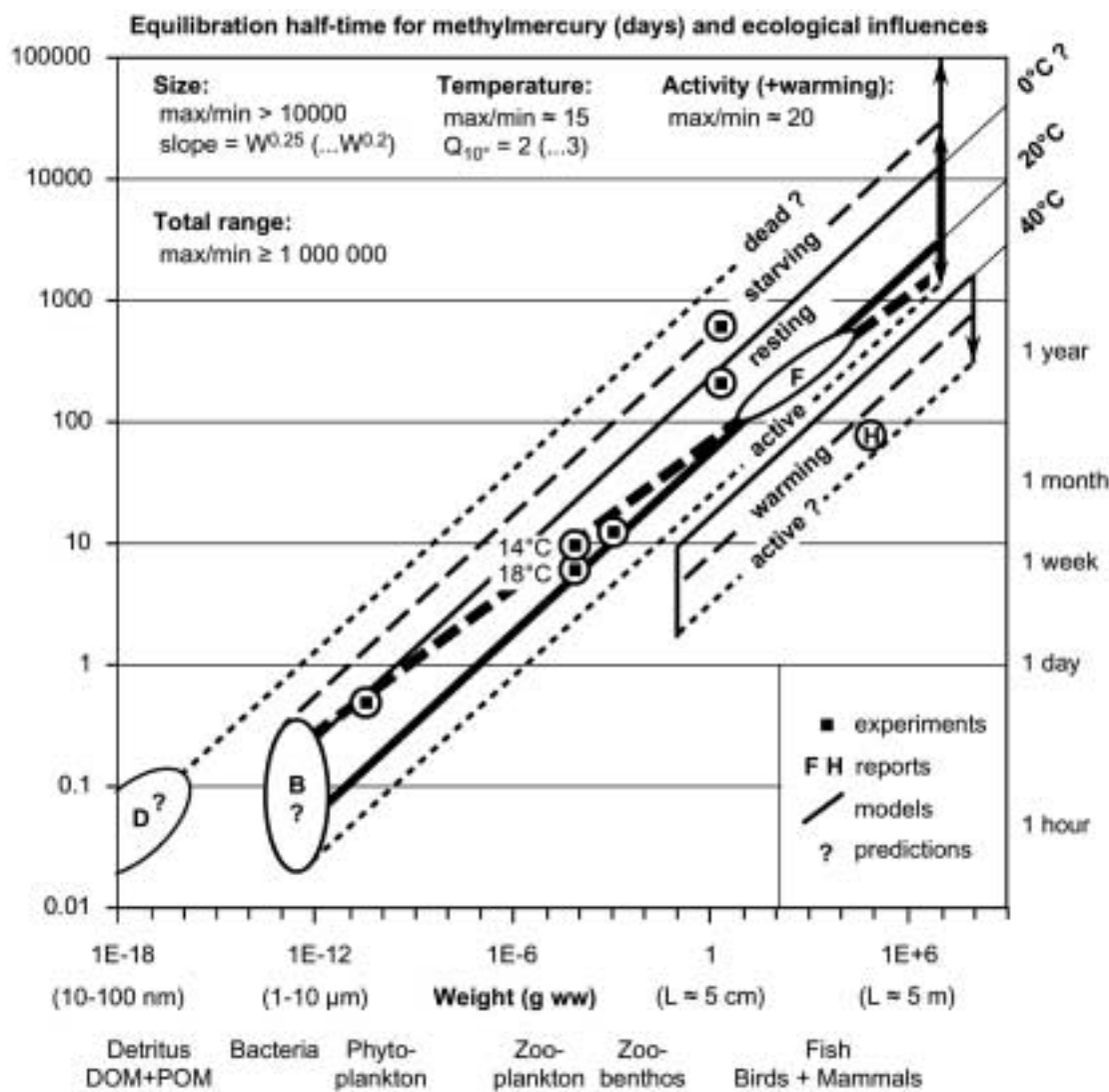

Fig. 1. Scope of methylmercury kinetics in aquatic organisms, expressed as whole-body equilibration half-times of accumulation or depuration (slowest component). Model slopes are based on allometric relationships between metabolic rate and body weight (Gillooly *et al.*, 2001). Bold lines show an extrapolation of observed equilibration half-times in moderately active fish normalized to 20°C (F, review by Trudel and Rasmussen, 1997) based on a quarter power relationship with organism size ($W^{0.25}$, bold) and an alternative relationship ($W^{0.2}$, bold dashed). Expected temperature effects (Gillooly *et al.*, 2001) are shown as departures that are about 2-fold per 10° (thin lines) to 3-fold (thin dashed lines). The latter can be interpreted as a combined effect of deviating body temperature as such and either a high metabolic activity required to maintain a high body temperature in endotherms (mammals and birds, here represented by humans, H) or a low metabolic activity in ectotherms during periods of minimal activity for e.g. hunting, food processing, and growth. Dotted lines indicate extremes of long-term metabolism, and arrows the metabolic scope at different temperatures. Experimental data (referring to 20°C except where otherwise indicated) are given for some common freshwater organisms: phytoplankton (*Scenedesmus quadricauda*), zooplankton (*Daphnia longispina*) at two temperatures, phantom midge larvae (*Chaoborus flavicans*), and small fish (*Carassius carassius*) at low activity and two different levels of food supply. Expected values are hypothetically indicated for bacteria (B, smallest living cells) and colloidal organic detritus (D, diffusion-controlled sorption/desorption without metabolic activity).

starvation, hibernation, low body temperature) may illustrate the metabolic enhancement of transport efficiency relative to passive diffusion: a hypothetical extrapolation of the metabolic scope suggests that death may slow down the turnover of trace elements and contaminants in organisms by about one and up to two orders of magnitude (Fig. 1) as long as tissues remain intact. Further, the equilibration half-times for methylmercury sorption/desorption on colloidal

organic matter such as humic substances may be estimated to the order of hours, based simply on particle size (Fig. 1).

In conclusion, quantitative predictions of ecological kinetics can be generated from simple scaling models and basic physical data, at least to the order of magnitude. If bioenergetic information (e.g. type of organism, level of activity, mode and rate of food processing, rate and efficiency of growth and reproduction) is included, deviations may eventually be further reduced, possibly to twofold or less. Relationships between the metabolism of trace substances and basic environmental parameters may at best assist in the search of general biokinetic models, or may at least be useful for assessing scopes of variability, formulating hypotheses, or designing studies requiring equilibrium.

Metabolic processes apparently exert a significant influence on the turnover of contaminants that are predominantly stored in biologically active compartments of soft tissues, such as methylmercury, (radio)cesium, and persistent organic pollutants (e.g. Hendriks, 1995, 1999; Hendriks and Heikens, 2001; Hendriks *et al.*, 2001; Meili, 1997). These also represent substances that unlike most metals have the potential of biomagnification along food chains, since they are not located in specific body tissues but fairly evenly distributed, which also contributes to their slow elimination. However, patterns may be different for contaminants that are superficially adsorbed, metabolized to other compounds, or immobilized in bones, shells, exoskeletons or internal precipitates (e.g. Rainbow, 2002). Further, metabolic influences may vary not only among contaminants but also among organisms and environments (e.g. Hutchins *et al.*, 1996-1998; Boisson *et al.*, 1997; Fisher *et al.*, 1999; Ke *et al.*, 2000; Wang, 2002). Finally, a key issue is to what extent biokinetics influence environmental concentrations in biota. In natural settings, biotic burdens represent a balance between uptake and elimination, and if metabolism influences both fluxes equally, its influence on biotic concentrations of contaminants may be negligible.